

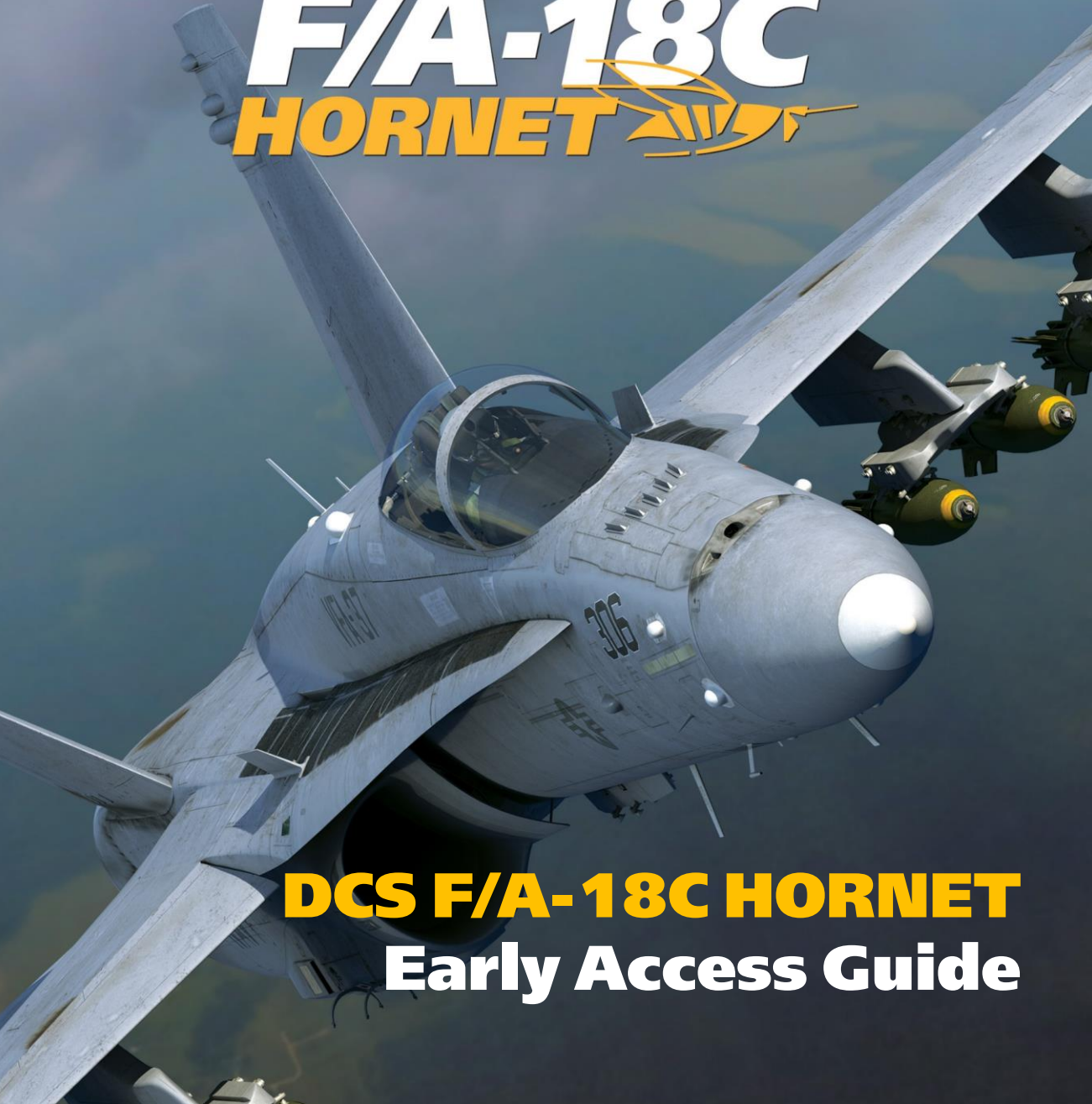

DIGITAL COMBAT SIMULATOR

F/A-18C HORNET



DCS F/A-18C HORNET
Early Access Guide

Contents

| | |
|---------------------------------------|----|
| HEALTH WARNING!..... | 6 |
| INSTALLATION AND LAUNCH..... | 7 |
| GAME PROBLEMS | 7 |
| USEFUL LINKS..... | 7 |
| CONFIGURE YOUR GAME..... | 8 |
| PLAY A MISSION..... | 12 |
| FLIGHT CONTROL..... | 13 |
| F/A-18C HORNET COCKPIT OVERVIEW | 15 |
| Left Instrument Panel | 17 |
| Center Instrument Panel | 21 |
| Right Instrument Panel | 25 |
| Left Vertical Panel..... | 27 |
| Left Console | 29 |
| Right Vertical Panel..... | 31 |
| Right Console | 33 |
| Control Stick..... | 36 |
| Throttles | 37 |
| DDI and AMPCD Pages | 38 |
| Support (SUPT) Pages..... | 38 |
| Tactical (TAC) | 44 |
| HEAD UP DISPLAY..... | 48 |
| PROCEDURES | 50 |
| Cold Start..... | 50 |
| Taxi | 57 |
| Normal Takeoff..... | 58 |
| Landing..... | 59 |
| HORNET COMMUNICATION SYSTEM | 64 |
| How to Use the Radios..... | 64 |
| UFC Radio Functions..... | 65 |
| HORNET MASTER MODES..... | 67 |

| | |
|---|-----|
| HORNET NAVIGATION (NAV) | 67 |
| How to Navigate Using Waypoints..... | 67 |
| Waypoint Navigation | 71 |
| TACAN Navigation..... | 73 |
| DATA Option Sublevel | 76 |
| A/C (Aircraft) Sublevel | 76 |
| WYPT (Waypoint) Sublevel..... | 77 |
| TCN (TACAN) Sublevel..... | 77 |
| Automatic Direction Finder (ADF) Navigation | 78 |
| How to Navigate Using ADF Beacons..... | 78 |
| Additional HSI Symbology | 79 |
| Setting a Course | 80 |
| Autopilot Relief Modes..... | 80 |
| HORNET AIR-TO-GROUND (A/G)..... | 82 |
| Air-to-Ground Stores Management System (SMS) Bombing Page | 82 |
| A/G Stores Programming | 84 |
| Air-to-Ground Ranging (AGR) RADAR..... | 86 |
| Air-to-Ground Bombing HUD..... | 86 |
| Continuously Computed Impact Point (CCIP) Bombing HUD..... | 86 |
| How to Bomb Using CCIP Mode..... | 87 |
| Automatic (AUTO) Bombing HUD | 88 |
| Manual (MAN) Bombing HUD | 94 |
| Air-to-Ground Gun and Rockets | 96 |
| How to Use A/G Guns..... | 96 |
| How to Use Rockets | 96 |
| A/G Gun SMS Page..... | 97 |
| Rockets SMS Page..... | 98 |
| A/G Gun and Rocket HUD | 99 |
| HORNET AIR-TO-AIR (A/A)..... | 102 |
| Air-to-Air RADAR..... | 103 |
| Basic Air-to-Air RADAR Information | 103 |
| Range While Search (RWS)..... | 105 |

| | |
|--|-----|
| How to Use RADAR in Beyond Visual Range Mode..... | 105 |
| Air-to-Air RADAR HOTAS Controls | 108 |
| Range While Search (RWS) DATA | 111 |
| Air Combat Maneuvering (ACM) Modes..... | 112 |
| Simulation (SIM) Mode..... | 114 |
| M61A2 Gun, Air-to-Air Mode (A/A GUNS) | 114 |
| How to Use the Gun Summary | 114 |
| A/A GUNS SMS Page..... | 114 |
| A/A GUNS HUD..... | 116 |
| Radar Not Tracking Mode | 116 |
| Training Mode..... | 119 |
| Radar Tracking Mode | 119 |
| AIM-9 Sidewinder Air-to-Air Missile | 124 |
| How to Use the AIM-9 Summary | 124 |
| IR Cool Switch | 124 |
| AIM-9 on the SMS Page..... | 125 |
| AIM-9 HUD | 126 |
| AIM-7 Sparrow Air-to-Air Missile | 132 |
| How to Use the AIM-7 Summary | 132 |
| AIM-7 SMS Page | 133 |
| AIM-7, No RADAR Tracking..... | 134 |
| AIM-7, RADAR Tracking..... | 135 |
| AIM-7 with L&S Target | 137 |
| HORNET DEFENSIVE SYSTEMS | 140 |
| Integrated Countermeasures Control Panel (ICMCP)..... | 141 |
| EW Page | 143 |
| Azimuth Indicator | 146 |
| Right Instrument Panel Warning / Advisory / Threat Display Panel | 149 |
| BIT..... | 150 |
| Control Indicator Panel | 151 |
| HOTAS | 152 |

HEALTH WARNING!

Please read before using this computer game or allowing your children to use it.

A very small proportion of people may experience a seizure or loss of consciousness when exposed to certain visual images, including flashing lights or light patterns that can occur in computer games. This may happen even with people who have no medical history of seizures, epilepsy, or "photosensitive epileptic seizures" while playing computer games.

These seizures have a variety of symptoms, including light-headedness, dizziness, disorientation, blurred vision, eye or face twitching, loss of consciousness or awareness even if momentarily.

Immediately stop playing and consult your doctor if you or your children experience any of the above symptoms.

The risk of seizures can be reduced if the following precautions are taken, (as well as a general health advice for playing computer games):

Do not play when you are drowsy or tired.

Play in a well-lit room.

Rest for at least 10 minutes per hour when playing the computer game.

INSTALLATION AND LAUNCH

You will need to be logged into Windows with Administrator rights in order to install the game.

After purchasing DCS: F/A-18C Hornet from our e-Shop, start DCS World. Select the Module Manager icon at the top of the Main Menu. Upon selection, your Hornet will automatically install.

DCS World is the PC simulation environment that the F/A-18C Hornet simulation operates within. When you run DCS World, you in turn launch DCS: F/A-18C Hornet.

As part of DCS World, the Su-25T Frogfoot attack aircraft and TF-51 training aircraft are also included for free.

After executing the DCS World icon on your desktop, the DCS World Main Menu page is opened. From the Main Menu, you can read DCS news, change your wallpaper by selecting either the F/A-18C Hornet or Su-25T Frogfoot icons at the bottom of the page, or select any of the options along the right side of the page. To get started quickly, you can select Instant Action and play any of the missions listed in the F/A-18C Hornet tab.

GAME PROBLEMS

If you encounter a problem, particularly with controls, we suggest you back up and then delete your Saved Games\User Name\DCS\Config folder, which is created by DCS on your operating system drive at first launch. Restart the game and this folder will be rebuilt automatically with default settings, including all of the controller input profiles.

If problems persist, we suggest consulting our online technical support forums at <http://forums.eagle.ru/forumdisplay.php?f=251>

USEFUL LINKS

DCS Homepage:

<http://www.digitalcombatsimulator.com/>

DCS: F/A-18C Hornet forum:

<https://forums.eagle.ru/forumdisplay.php?f=557>

DCS Wiki:

http://en.wiki.eagle.ru/wiki/Main_Page

CONFIGURE YOUR GAME

Before jumping into the Hornet cockpit, the first thing we suggest is to configure your game. To do so, select the Options button at the top of the Main Menu screen. You can read a detailed description of all Options in the DCS World Game Manual. For this Early Access Guide, we will just cover the basics.

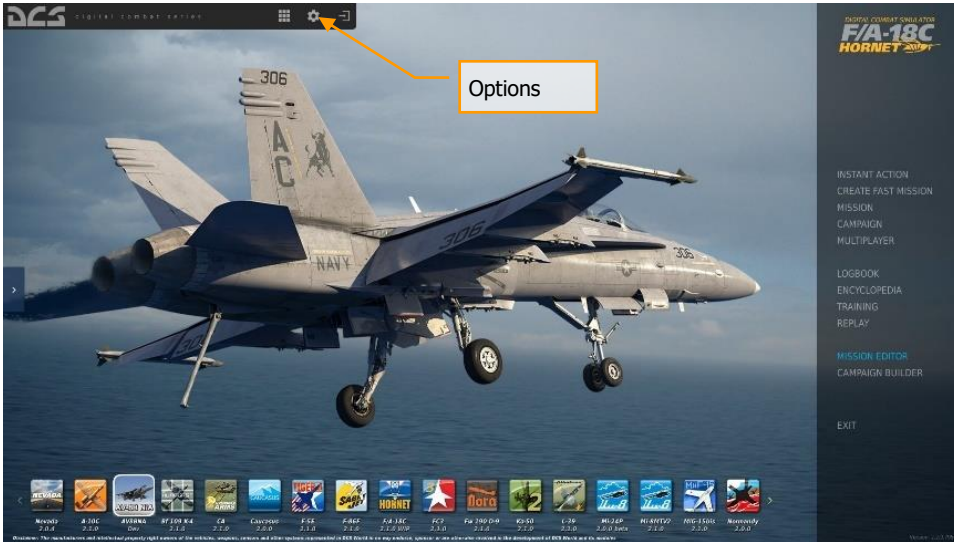

Figure 1. DCS World Main Menu

Upon selecting the Options screen, you will see seven tabs along the top of the page.

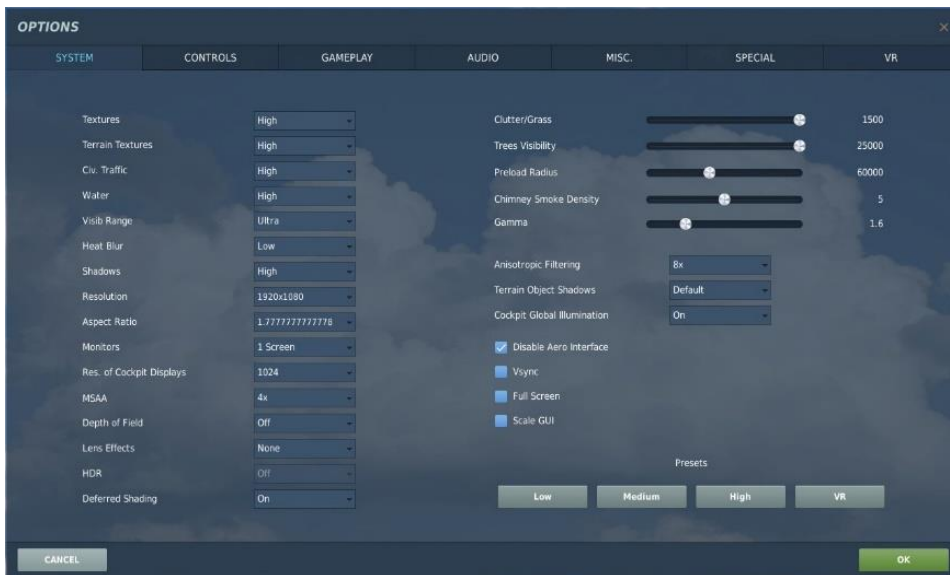

Figure 2. DCS World Options

SYSTEM. Configure your graphics options to best balance aesthetics with performance. You have PRESET options along the bottom of the page, but you can further adjust your graphics settings to best suit your computer. If you have lower performance, we suggest selecting the Low PRESET and then increase graphics options to find your best balance.

CONTROLS. Set up your controls and functional bindings. Let's take a closer look at this page:

First, select the aircraft you wish to assign control inputs to by use of the Aircraft Selection drop-down. Next, along the left side of the screen are all the ACTIONS associated with the selected Input Function drop down. To the right are all the detected input devices that have been detected to include keyboard, mouse, and any joysticks, throttles and rudder pedals.

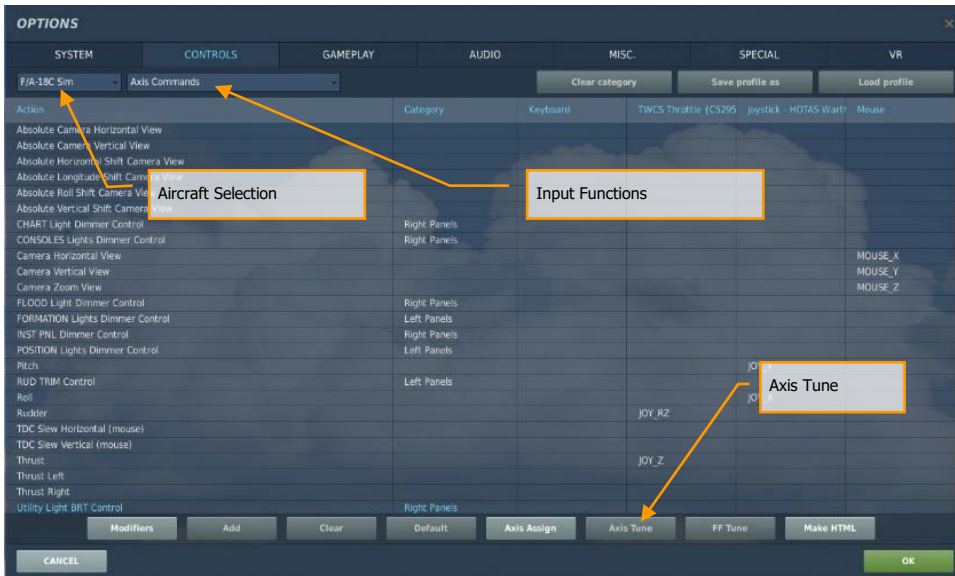

Figure 3. Controls Configuration

1. **Aircraft Selection.** From this drop-down menu, select F/A-18C Sim.
2. **Input Functions.** This displays various categories of input functions, such as axis devices, views, cockpit functions, etc. To assign a function, double mouse-click in the box that corresponds to the desired input function and the input controller device. Once selected, press the button or move the axis of the device to assign it.
3.
 - a. Example 1: if setting a pitch axis, first select AXIS COMMANDS from the Input Functions drop down. Find the box where your Joystick input device and the Pitch Action intersect, and double mouse-click in the box. In the ADD ASSIGNMENT PANEL, move your joystick forward and back to assign the axis. Press OK when done.
 - b. Example 2: if setting a keyboard of HOTAS command like cycle the landing gear, first select ALL as the Input Function category. Find the box where your input device and the LANDING GEAR CONTROL HANDLE – UP/DOWN Action intersect, and double mouse-click in the box. In the ADD ASSIGNMENT PANEL, press the keyboard or controller device button you wish to assign to the action. Press OK when done.
4. **Axis Tune.** When assigning an axis (like X and Y axis for a joystick), you can use this sub-page to assign a dead zone, response curve, and other tuning. This can be very useful if you find the aircraft overly sensitive to control.

GAMEPLAY. This page primarily allows you to adjust the game to be as realistic or casual as you want it to be. Choose from many difficulty settings like labels, tool tips, unlimited fuel and weapons, etc.

AUDIO. Use this page to adjust the audio levels of the game. You also have the option to turn on and off different audio effects.

MISC. This is a catch-all of features to further tune the game to your preference.

VR. The VR tab allows you to enable support for the Oculus Rift and HTC Vive and adjust its functionality. When using VR, be particularly aware of the Pixel Density setting as it can have a dramatic effect on game performance.

PLAY A MISSION

Now that you have configured your game, let's get to why you purchased DCS: F/A-18C, to fly some missions! You have several options to fly a single-player mission.



Figure 4. DCS World Main Menu

1. **INSTANT ACTION.** Simple missions that place you in the task of your choice. We will be using several of these in this Early Access Guide to test what you learn.
2. **CREATE FAST MISSION.** Set various mission criteria to allow a mission to be created for you.
3. **MISSION.** More in-depth, stand-alone missions.
4. **CAMPAIGN.** Linked missions to create a campaign narrative.
5. **MULTIPLAYER.** Create your own or join an internet server.
6. **MISSION EDITOR.** Use this very powerful Mission Editor to create your own missions.

On the Main Menu page, you the options to fly the Hornet in an INSTANT ACTION mission, CREATE FAST MISSION, load a MISSION, play a Hornet CAMPAIGN when campaigns are available, or create a mission in MISSION EDITOR. You also have the option to jump online and fly with others.

Select the INSTANT ACTION from the right side of the screen. From here, you will be presented a number of F/A-18C Hornet INSTANT ACTION missions to choose from.

To get started, we suggest the FREE FLIGHT mission. Later on, you can also use these missions to practice starting up the aircraft, takeoffs, landings, navigation and sensor / weapon employment.

FLIGHT CONTROL

Primary aircraft flight controls include the flight control stick, throttle, and rudder pedals. The stick is used to roll the aircraft left and right to perform turns and pitch the nose up and down to climb or descend. The throttle is used to control engine power and resulting airspeed. The pedals are used to yaw the airplane left and right using the rudder (like a boat). Pedal use in flight is limited to eliminating sideslip and helping to coordinate smooth turns, but they are also used on the ground to turn the nose wheel when taxiing.

To fly the aircraft to the right or left: roll the aircraft in the direction you wish to go and gently pull back on the stick. The greater you pull back on the stick, the faster your turn rate will be and the more speed you will lose.

When flying from the cockpit, you can toggle the Controls Indicator display by pressing **|RCtrl + Enter|** to see a visual reference of the positions of your flight controls.

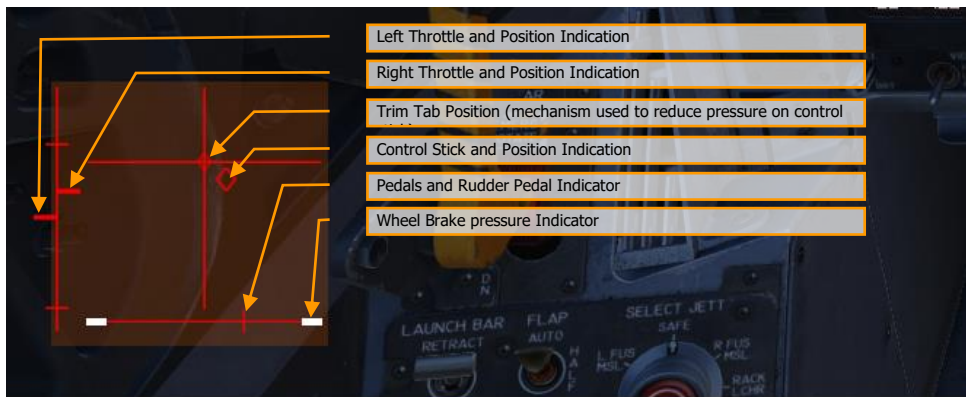

Figure 5: Controls Indicator display

Maximum Pitch Trim Deviation Indicator. Before takeoff, the pitch trim indicator (5) shall be set approximately to a neutral position

If you are flying only with a keyboard, the primary flight control keys will be: arrow keys to control roll and pitch, **|Numpad+|** and **|Numpad-|** to control throttle, and **|Z|** / **|X|** to control the rudder pedals. If you do have a joystick, it may be equipped with a throttle handle and/or a twist grip, which will allow you to control the rudder pedals.

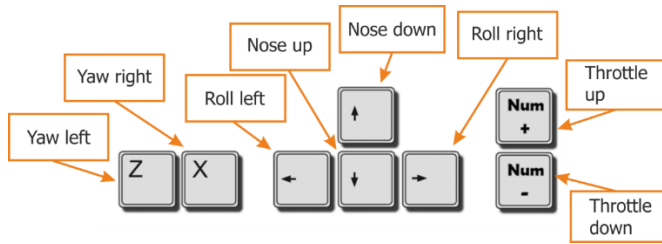

Figure 6. Flight Key Commands

F/A-18C HORNET COCKPIT OVERVIEW

Once in the cockpit, it's best to have a general understanding of where the various controls are located. To help locate items more easily, we have broken the Hornet cockpit into eight primary areas. In later sections of this Early Access Guide, we will reference these locations.

Instant Action Mission Practice: Hornet Cold and Dark

Hornet Instant Action Mission: Hornet Cold and Dark. Use this mission to explore then cockpit and become familiar with its layout. To move your view:

- Keypad 8: Up
- Keypad 6: Right
- Keypad 2: Down
- Keypad 4: Left
- Keypad *: Zoom In
- Keypad /: Zoom Out

Press pressing [LEFT ALT + C] toggles mouse control between interacting with the cockpit and controlling your view.

What follows is a summary description of cockpit functions included in this Early Access version that are generally not described elsewhere in this document.

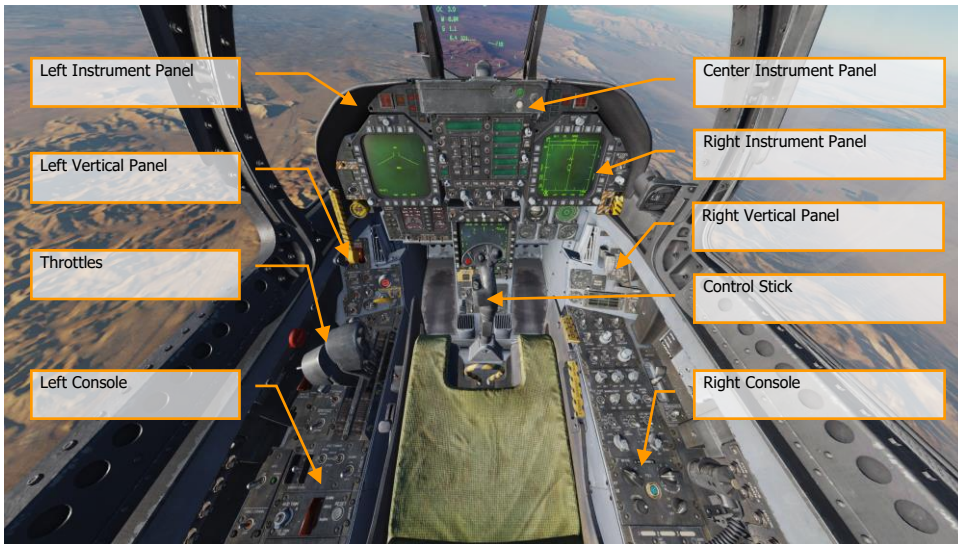

Figure 7. F/A-18C Cockpit Overview

Left Instrument Panel

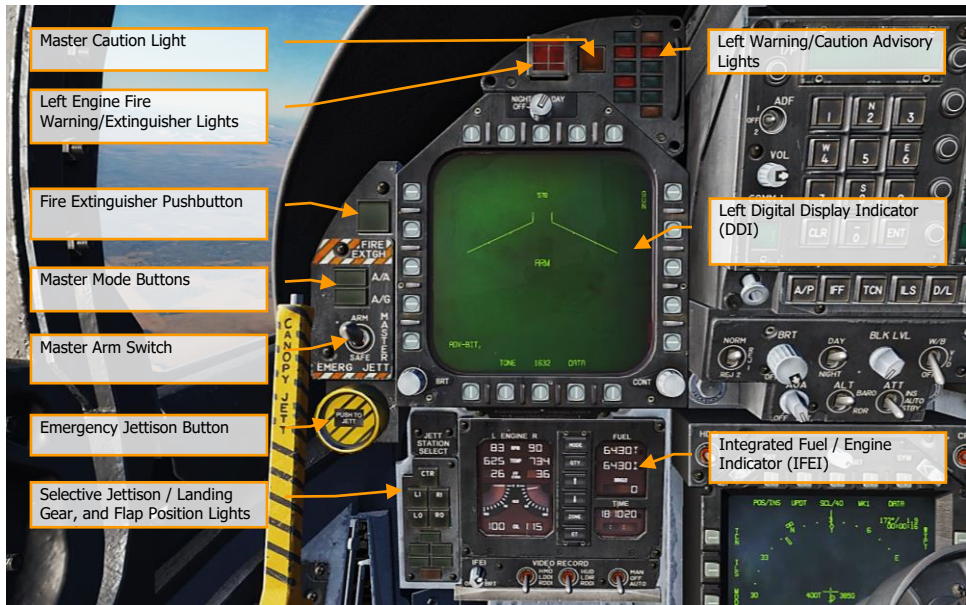

Figure 8. Left Instrument Panel

1. **Left Digital Display Indicator (DDI).** The left DDI is a 3-color display that provides desired information to control various aircraft functions and displays. There are 20 pushbuttons on the DDI which are used to select the function and the mode for proper indicator display.
 - **Brightness Selector Knob.** Placing this rotary knob to OFF prevents the DDI from operating. Placing the knob to NIGHT provides a lower brightness control range, and the DAY setting provides a more bright default setting.
 - **Brightness Control.** This knob varies the intensity of the symbols and text.
 - **Contrast Control.** This knob varies the contrast between symbology and the dark background on any level of brightness.
2. **Master Mode Buttons.** These two buttons allow you to change between Air-to-Air (A/A) [1] and Air-to-Ground (A/G) [2] master modes. There are three master modes of operation: navigation (NAV), air-to-air (A/A), and air-to-ground (A/G). The controls, displays, and the avionic equipment operation are tailored as a function of the master mode you select.
3. **Master Arm Switch [M].** This switch controls the ability for weapons to be employed or jettisoned. Weapons can only be released when this switch is set to the ARM position.
4. **Emergency Jettison Button.** The emergency jettison button, labeled EMERG JETT jettisons stores from the parent bomb racks on external stores stations 2, 3, 5, 7 and 8. Holding the button down for 375 msec initiates jettison.

5. **Selective Jettison / Landing Gear, and Flap Position Lights Panel.** This panel has three primary functions; the top is used to selectively select stations to jettison and the bottom two provide landing gear and flaps status.
- **Station Jettison Select Buttons.** These buttons are labeled CTR (center), LI (left inboard), RI (right inboard), LO (left outboard) and RO (right outboard). Pressing a button illuminates it and selects the weapon station for jettison. Selective jettison is performed by the selective jettison knob in conjunction with the station jettison select buttons.
 - **Landing Gear Indications.** There are three green landing gear position lights marked NOSE, LEFT and RIGHT. The lights indicate that the gear is down and locked, or that a gear link is not locked.
 - **Flap Indications.** A green light indicates the aircraft is within flight parameters for the flight control computer to adjust flap scheduling in accordance with the selected switch position.
 - **HALF.** FLAP switch at HALF setting and airspeed below 250 knots.
 - **FULL.** FLAP switch at FULL setting and airspeed below 250 knots.
 - **FLAPS.** FLAP switch HALF or FULL settings and airspeed over 250 knots, abnormal flap condition (any flap is off or lacks hydraulic pressure), in spin recovery mode, or GAIN switch in ORIDE position.
6. **Integrated Fuel / Engine Indicator (IFEI).** The integrated fuel/engine indicator (IFEI) engine display contains a left and right liquid crystal display for RPM (N2)%, TEMP (EGT)°C, FF (fuel flow) PPH, NOZ (nozzle position)%, and OIL (oil pressure) psi. During engine starts without external electrical power, only RPM and TEMP are displayed by battery power until the APU comes on line. With the APU on line or external power, all engine data is displayed.
- **Engine RPM.** Displays engine N2 rpm from 0 to 100%. There is no RPM indication of afterburner.
 - **Exhaust Gas Temperature (TEMP).** Displays turbine exhaust gas temperature (EGT) from 0 to 1,999°C.
 - **Engine Fuel Flow (FF).** Displays main engine fuel flow only (afterburner fuel flow is not displayed). Range is 300 to 15000 Pounds Per Hour (PPH) with 100 pound per hour increments. The tens of units positions have fixed zeros. When fuel flow is less than 320 PPH, zero is displayed.
 - **Engine Nozzle Position (NOZ).** Displays exhaust nozzle position from 0 to 100% open in 10% increments.
 - **Engine Oil Pressure (OIL).** Displays engine oil pressure from 0 to 195 psi in 5 psi increments.

The IFEI fuel display window contains three digital counters to provide dynamic fuel quantity indications. The upper digital counter displays total aircraft fuel quantity (10-pound increments). The middle digital counter displays total internal fuel quantity (10-pound increments). A digital counter legend is displayed to the right of the upper and middle counters (T - total fuel, I - internal fuel). The lower digital counter displays the selected BINGO fuel quantity (100-pound increments).

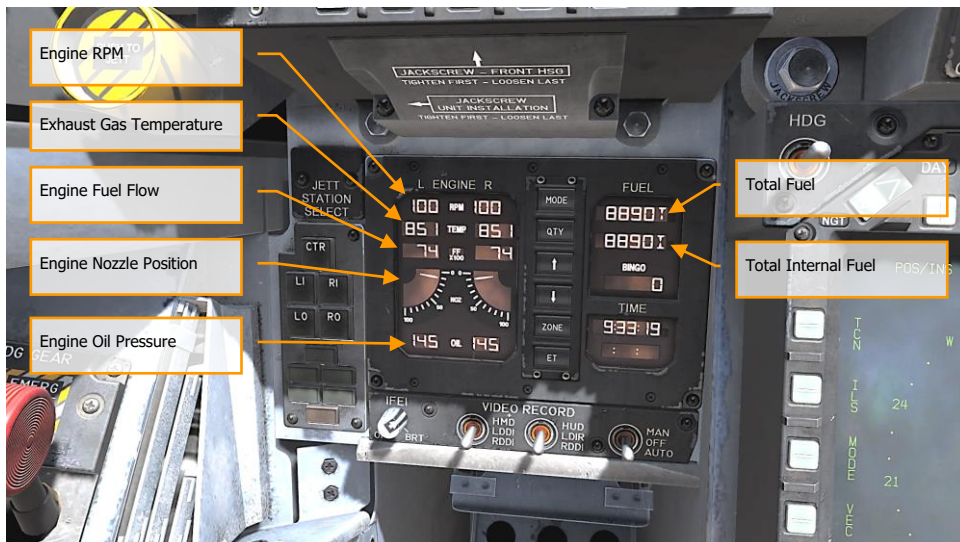

Figure 9. Integrated Fuel / Engine Indicator (IFEI)

7. **Left Engine Fire Warning/Extinguisher Lights.** If a fire is detected in the left engine, this indicator, marked FIRE, will be lit along with an "Engine Fire Left, Engine Fire Left" audio warning. This is a steady state, red light. To enable the fire bottle to discharge into the selected engine/AMAD bay, the pilot must lift the guard over the FIRE warning light and press the FIRE button. The button has two positions. Pushed in shuts off fuel flow to the engine and arms the fire extinguisher and the READY light will illuminate. Pushing this FIRE Warning button in once more toggles the button to the out position and the fuel valve will open again for that engine and the READY light will turn off.
8. **Master Caution Light.** A yellow MASTER CAUTION light, on the upper left part of the instrument panel, comes on when any of the caution lights or caution displays come on. The MASTER CAUTION light goes out when it is pressed (reset). An audio tone is initiated whenever the MASTER CAUTION light comes on. This button is also used to "re-stack" caution and advisory notices.
9. **Left Warning/Caution Advisory Lights.** The Left Warning/Caution Advisory Lights provide visual indications of normal aircraft operation and system malfunctions affecting safe operation of the aircraft. A red warning light normally indicate a systems malfunction that could be a severe hazard to further flight, and may require immediate action. Yellow caution lights and displays normally, but not always, indicate malfunctions that require attention but not immediate action. After the malfunction has been corrected, warning and caution lights and caution displays go out. Advisory lights and displays indicate safe or normal conditions and supply information for routine purposes.

- **L BLEED.** Will light when the Fire and Bleed Air Test Switch is pressed or bleed air leak or fire (600F degrees) has been detected in the left engine bleed air ducting. If illuminated, the left bleed valve is automatically closed. Will light when TEST A or TEST B switch is held or a bleed air leak or fire has been detected in the left engine ducting. A "Bleed Air Left, Bleed Air Left" audio message will also sound. L BLD OFF caution will be displayed on the LDDI.
 - **R BLEED.** Will light when the Fire and Bleed Air Test Switch is pressed or bleed air leak or fire (600F degrees) has been detected in the right engine bleed air ducting. If illuminated, the right bleed valve is automatically closed. Will light when TEST A or TEST B switch is held or a bleed air leak or fire has been detected in the right engine ducting. A "Bleed Air Right, Bleed Air Right" audio message will also sound. R BLD OFF caution will be displayed on the LDDI.
 - **SPD BRK.** Will light anytime the speed brake is not fully retracted.
 - **STBY.** When ALQ-165 ECM mode switch is set to STBY on the ECM control panel, the STBY light indicates that the ECM Jammer is in warm up mode. This will last five minutes and then time out and extinguish.
 - **L BAR (Red).** Launch bar malfunction. Nose gear cannot retract. The launch bar can only be extended with weight on wheels.
 - **L BAR (Green).** Launch bar extended with weight on wheels. Will extinguish when the launch bar switch is in the UP position (catapult shuttle holds the launch bar in the extend position until the end of the catapult stroke).
 - **REC.** Indicates that the aircraft is being illuminated by a threat RADAR.
 - **XMIT.** Lit when ECM Jammer is transmitting.
 - **GO.** Indication of successful BIT test of ALQ-165. Will remain illuminated until BIT mode is deselected.
 - **NO GO.** Indication of unsuccessful BIT test of ALQ-165. Will remain illuminated until BIT mode is deselected. ALQ-126 is inoperable.
10. **Fire Extinguisher Pushbutton.** This switch has two lights. A yellow light labeled READY and a green light labeled DISCH (discharge). When READY is on, the fire extinguisher bottle is armed. The READY light comes on when the appropriate fire warning/extinguisher light is lit. Pressing an engine fire warning/extinguisher light shuts off fuel to the engine at the feed tank. With READY on, pressing the fire extinguisher pushbutton discharges the fire extinguisher bottle and turns on the DISCH light.

Center Instrument Panel

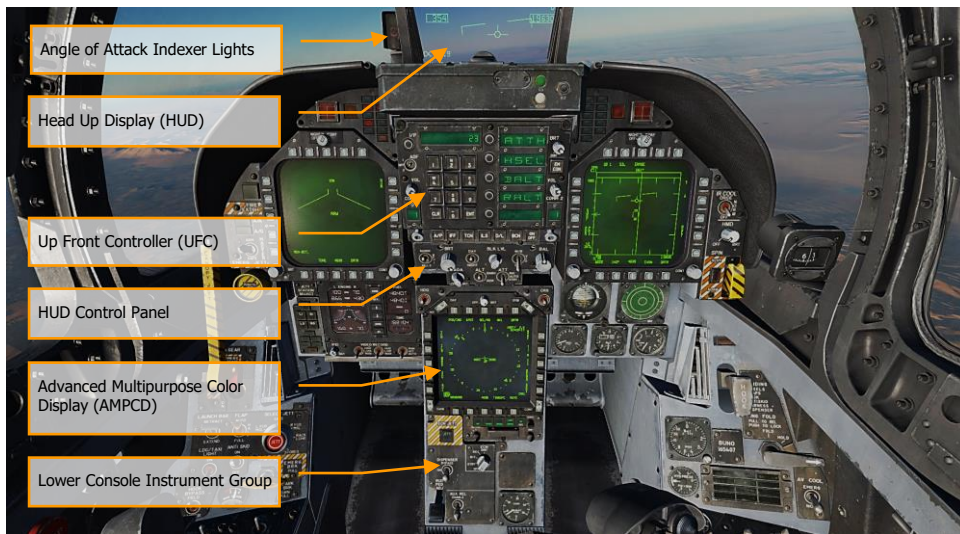







Figure 10. Center Instrument Panel

1. **Head Up Display (HUD).** The HUD is used as the primary flight instruments, weapon status, and weapon delivery display for the aircraft under all selected conditions. The HUD receives attack, navigation, situation, and steering control information from the left or right DDI symbol generators (under mission computer control), and projects symbology on the combining glass for head-up viewing. The HUD will be discussed in much greater detail later in this guide.
2. **Angle of Attack Indexer Lights.** The AOA indexer is mounted to the left of the HUD. It displays approach angle of attack (AoA) with lighted symbols. Corresponding AOA indications are shown on the HUD.

| SYMBOL | AIRSPEED | AOA |
|---|----------|---------------------------|
|  | Fast | 0° to 6.9° 9.3° to 90.00° |

| | | |
|---|---------------|---------------------------|
|  | Slightly fast | 6.9° to 7.4° 8.8° to 9.3° |
|  | On speed | 7.4° to 8.8° |
|  | Slightly slow | 8.8° to 9.3° |
|  | Slow | 9.3° to 90.00° |

3. **Upfront Controller (UFC).** The UFC is on the main instrument panel below the HUD. The UFC is used to select the autopilot, ILS, data link, and radios. The UFC is used in conjunction with the two DDIs and the AMPCD to enter navigation, sensor, and weapon delivery data. The UFC will be discussed in greater detail in the communications, navigation, and procedures section of this guide.
4. **HUD Control Panel.** The HUD control panels allows the pilot to adjust the HUD display and how some data is presented.



Figure 11. HUD Control Panel

- **HUD Symbology Reject Switch.** This three-position toggle switch has positions of NORM, REJ 1, and REJ 2. With the switch placed to NORM, the normal amount of symbology is provided for all HUD displays. Placing the switch to REJ 1 removes aircraft Mach number, aircraft G's, bank angle and pointer, airspeed box, altitude box, peak positive G, and required ground speed cue from the HUD. Placing the switch to REJ 2 removes all REJ 1 symbology plus the heading scale, current heading indication (caret/T), command heading marker, NAV/TACAN range, and the ET/CD timer.
 - **HUD Symbology Brightness Control.** This knob is used to turn on the HUD and then varies the display intensity.
 - **AOA Indexer Control.** This knob controls the brightness of the AoA indexer lights.
 - **HUD Symbology Brightness Selector Knob.** This is a two-position toggle switch with positions of DAY and NIGHT. Placing the switch to DAY provides maximum symbol brightness in conjunction with the HUD symbology brightness control. With the switch set to NIGHT, a reduced symbol brightness is provided in conjunction with the HUD symbology brightness control.
 - **Altitude Switch.** The ALT switch is used to select either RADAR altitude or barometric altitude for display on the HUD and as the primary altitude source for the mission computer. When the switch is set to RDR (RADAR), the altimeter altitude followed by an R is displayed in the upper right portion of the HUD display. If RADAR altitude becomes invalid, such as the aircraft exceeding the 5,000 feet AGL RADAR altimeter limit, barometric altitude is displayed and a B next to the altitude flashes to indicate barometric altitude is being displayed.
5. **Advanced Multipurpose Color Display (AMPCD).** The AMPCD (generally referred to as just the MPCD) is a full-color, NVG compatible digital display capable of providing any MENU selectable format except the A/G RADAR display. The MPCD is driven by either the Digital Map Set (DMS) for HSI displays, or the left DDI for all other MENU selectable formats. Four momentary two-position rocker switches and a rotary knob, located on the front of the MPCD, permit control of MPCD off/brightness, night/day viewing modes, symbology, gain, and contrast.
- **Off/Brightness Control.** This rotary switch is located in the top-center of the MPCD and is used to turn the AMPCD on and off or to select the brightness level.
 - **Night/Day Brightness Selector.** This rocker switch is located in the upper left corner of the MPCD and is used to select the lower brightness control (night) range and disable automatic contrast control (NITE position selected) or to select the higher brightness control (day) range (DAY position selected).
 - **Symbology Control.** Momentary actuations of the upper half of the switch incrementally narrows the symbology, making it sharper and dimmer. Momentary actuations of the lower half incrementally widens the symbology, making it brighter and less sharp.
 - **Gain Control.** Momentary actuations of the upper half of the switch incrementally increases background video brightness. Momentary actuations of the lower half incrementally decreases video brightness.

- **Contrast Control.** Momentary actuations of the upper half of the switch incrementally increase the contrast of the display. Momentary actuations of the lower half incrementally decrease the contrast of the display.
 - **Heading and Course Set Switches.** At either side of the top of the MPCD are the Course (CRS) and Heading (HDG) switches that allow the pilot to manually set course and headings on the HSI. Both switches are spring-loaded to the center position, but can be held up to increase value (degrees) or held down to decrease value (degrees). Increase Heading $|\text{LALT} + \text{LSHIFT} + 2|$ and decrease $|\text{LALT} + \text{LSHIFT} + 1|$. Increase course $|\text{LALT} + \text{LSHIFT} + 4|$ and decrease $|\text{ALT} + \text{LSHIFT} + 3|$.
6. **Lower Console Instrument Group.** Aside from the cabin pressure gauge, this group of instruments is dedicated toward defensive systems. These will be discussed in the Defensive Systems portion of this guide.

Right Instrument Panel

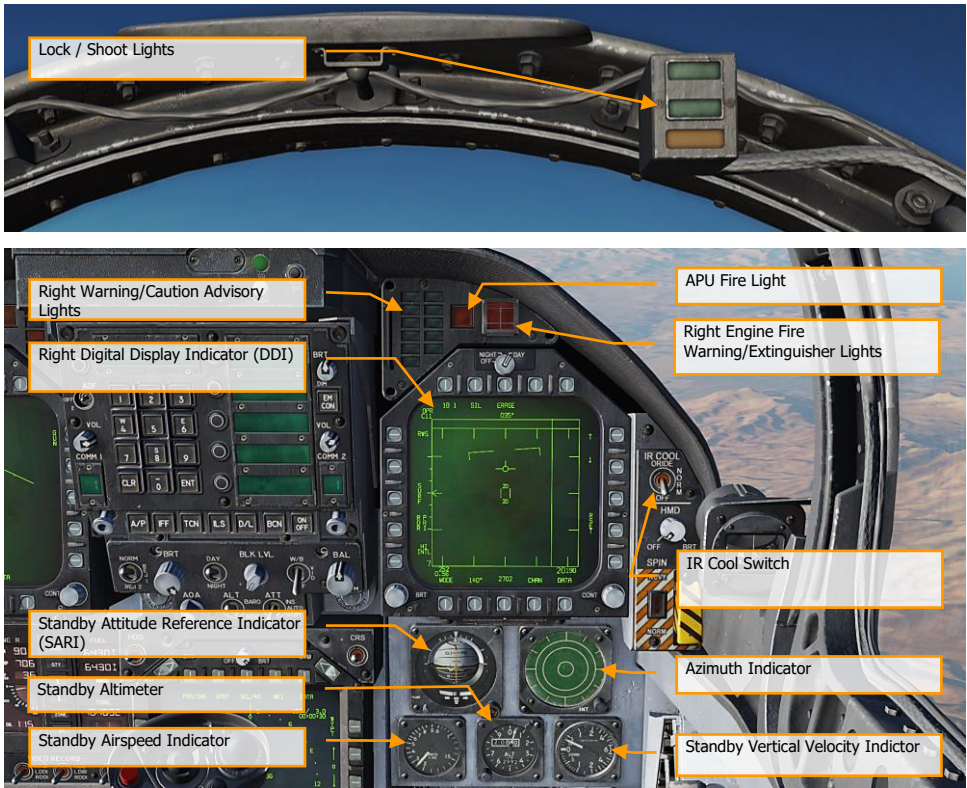

Figure 12. Right Instrument Panel

- Lock / Shoot Lights.** The Lock/Shoot cue function is provided during air-to-air (A/A) operation for the AIM-9 Sidewinder and A/A gun mode. This function provides a visual indication for RADAR lock on (LOCK light) and when weapon release interlocks are satisfied (SHOOT light/SHOOT cue).
 - Lock: Single Target Track (STT) and target within Rmax range.
 - Shoot / Steady / Missile: target locked and within Rmax range.
 - Shoot / Flashing / Missile: target locked and within Rne range.
 - Shoot / Steady / Gun: target within solution.

The strobe light below the SHOOT cue will also flash when shot is valid.

The Shoot light function is also provided during air to ground (A/G) rocket delivery, and with no weapon selected, shoot light is functional for A/G gun mode when gun is selected on left DDI. Lock light is not functional during A/G mode operation.

2. **Right Warning/Caution Advisory Lights.** The Right Warning/Caution Advisory lights provide visual indications of the recorder and the onboard Threat Warning System (TWS). See Defensive Systems Chapter for greater details.
 - **DISP.** Countermeasure dispense program is active.
 - **SAM.** Surface-to-Air Missile tracking RADAR locked to aircraft. Light is solid when RADAR is tracking and flashing when guiding a missile.
 - **AI.** Airborne Intercept (AI) RADAR locked to aircraft.
 - **AAA.** Ant-Aircraft Artillery (AAA) fire control RADAR locked to aircraft. This is a steady light for all RADAR directed AAA except ZSU-23-4 in which the light will flash at 3 Hz.
 - **CW.** Aircraft illuminated by Continuous Wave (CW) RADAR.
3. **APU Fire Light.** The APU Fire Light will light when a fire has been detected in the APU compartment.
4. **Right Engine Fire Warning/Extinguisher Lights.** If a fire is detected in the right engine, this indicator will be lit. It will light when a temperature greater than 1,000 degrees F is detected in the right engine bay.
5. **Right Digital Display Indicator (DDI).** The right DDI functions identically to the left DDI.
6. **IR Cool Switch.** Manually provides coolant to AIM-9 seekers. See AIM-9 procedures section of this guide.
7. **Standby Attitude Reference Indicator (SARI).** This is a self-contained instrument to indicate aircraft pitch, roll, and yaw. Cage and increase pitch |LALT + LSHIFT + V| cage and decrease pitch |LALT + LSHIFT + X|
8. **Azimuth Indicator.** Also referred to as the RADAR Warning Receiver (RWR), this is discussed in the Defensive Systems section of this guide.
9. **Standby Airspeed Indicator.** Indication of airspeed in knots x100.
10. **Standby Altimeter.** Indication of aircraft barometric altitude. Increase |LALT + LSHIFT + S| and decrease |LALT + LSHIFT + A|
11. **Standby Vertical Velocity Indicator.** Indication of aircraft positive or negative change of altitude rate.

Left Vertical Panel

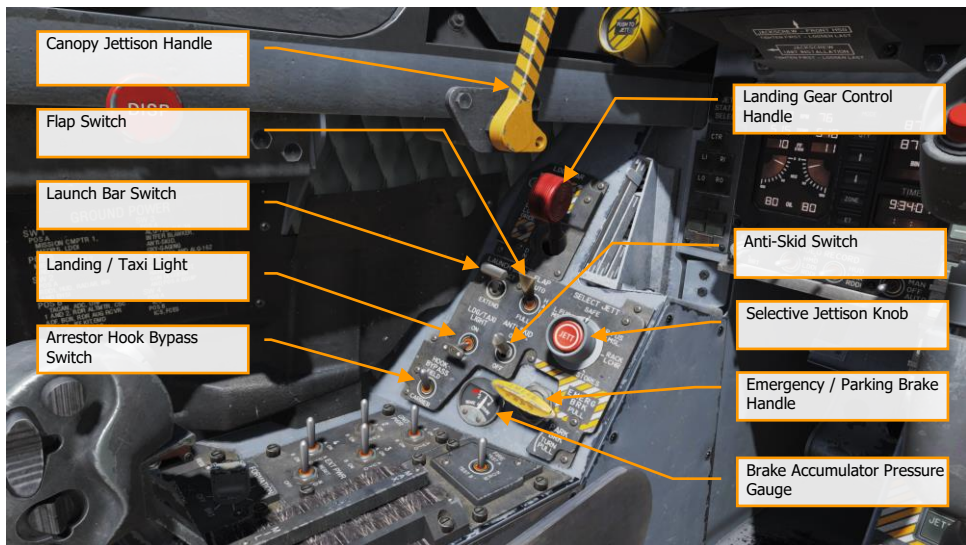

Figure 13. Left Vertical Panel

1. **Canopy Jettison Handle.** The black and yellow striped canopy jettison handle is on the left inboard canopy sill just aft of the instrument panel. Pulling the handle aft fires the canopy jettison system.
2. **Landing Gear Handle.** The landing gear is controlled by a two-position, wheel-shaped handle on the lower left side of the main instrument panel. Two conditions must be met before the gear can be raised: the aircraft must sense that weight is off all three landing gear and the launch bar must be retracted. [|G|](#)
3. **Launch Bar Switch.** Raises and lowers the carrier takeoff-required launch bar.
4. **Flap Switch.** The FLAP switch selects which of the two flight control computer modes (auto flap up or takeoff and land) is active and thus determines the flight characteristics for those conditions.
 - **AUTO.** Without Weight Off Wheels (WOW), leading and trailing edge flaps are scheduled as a function of AoA. With WOW, leading and trailing edge flaps and aileron droop are set to 0°. [|F|](#)
 - **HALF.** Below 250 knots, leading edge flaps are scheduled as a function of AoA. Trailing edge flaps and aileron droop are scheduled as a function of airspeed to a maximum of 30° at approach airspeeds. Above 250 knots, the flaps operate in the auto flap up mode and the amber FLAPS light comes on. On the ground, the leading edge flaps are set to 12°. The trailing edge flaps and aileron droop are set to 30°. With the wing unlocked, aileron droop is set to 0°. [|LSHIFT + F|](#)

- **FULL.** Below 250 knots, leading edge flaps are scheduled as a function of AoA. Trailing edge flaps and aileron droop are scheduled as a function of airspeed to a maximum of 45° flaps and 42° aileron droop at approach airspeeds. Above 250 knots, the flaps operate in the auto flaps up mode and the amber FLAPS light comes on. On the ground, the leading edge flaps are set to 12°. The trailing edge flaps are set to 43° to 45° and aileron droop to 42°. With the wings unlocked, aileron droop is set to 0°. [LCTRL + F]
5. **Selective Jettison Knob.** The selective jettison knob on the left vertical panel has rotary positions L FUS MSL, SAFE, R FUS MSL, RACK/LCHR, and STORES. L FUS MSL and R FUS MSL selects the required fuselage missile for jettison. The RACK/LCHR and STORES positions select what is to be jettisoned from the weapon stations selected by the station jettison select buttons. The JETT center pushbutton activates the jettison circuits provided the landing gear is up and locked and the master arm switch is in ARM. The SAFE position prevents any selective jettison.
 6. **Landing / Taxi Light.** This is a combination landing and taxi light is on the nose gear strut. The light is controlled by the LDG/TAXI light switch on the left vertical panel.
 - **OFF.** Light is off.
 - **ON.** If the landing gear handle is in DN and the landing gear is down, the light is on.
 7. **Anti-Skid Switch.** The anti-skid circuit prevents brake application on landing until wheel speed is over 50 knots, or if a wet runway delays wheel spin-up, 3 seconds after touchdown. A locked wheel protection circuit releases the brakes if the speed of one main wheel is 40% of the other main wheel. The locked wheel protection circuit is disabled at about 35 knots. The anti-skid system is totally disabled below 10 knots. Anti-skid is used for airfield operation, but not for carrier operations.
 8. **Emergency / Parking Brake Handle.** The emergency brake system is activated by pulling the emergency/parking brake handle out to the detent. The system is deactivated by pushing the emergency/parking brake handle back into the stowed position. The parking brake system is activated by rotating the emergency/parking brake handle 90° counterclockwise from the horizontal stowed position and pulling it out to a positive locked position.
 9. **Brake Accumulator Pressure Gauge.** Brake accumulator pressure is shown on a pressure gage on the lower left corner of the main instrument panel and is redlined to indicate pressure below 2,000 psi. 3,000 psi is a normal level.
 10. **Arrestor Hook Bypass Switch.** With this switch set to the CARRIER position, the AoA Indexer Lights will light solid when the arrestor hook and landing gear are down and locked. It will however flash if the arrestor hook is up. When set to FIELD, the AoA Indexer Lights will stay solid when the arrestor hook is not down.

Left Console

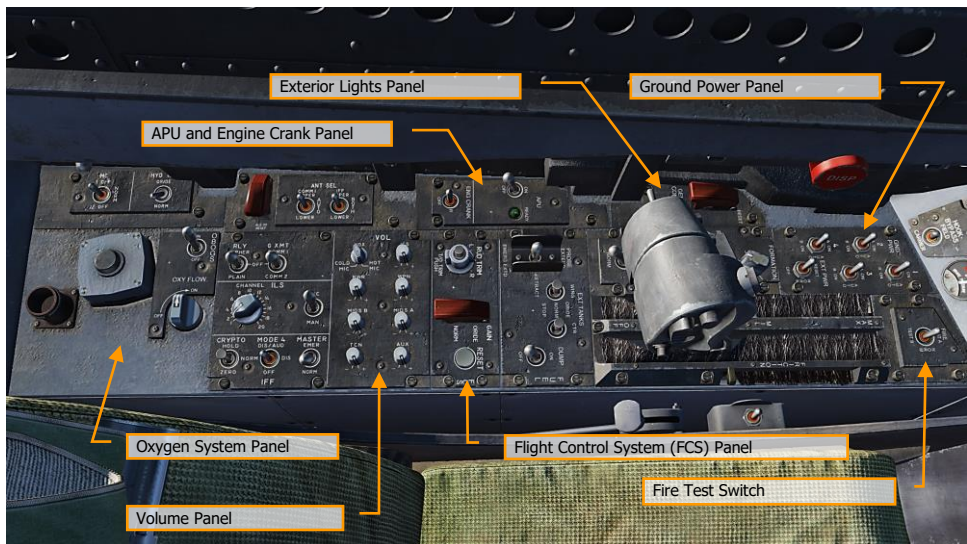

Figure 14. Left Console

1. **Ground Power Panel.** If wishing to not use the battery to start the aircraft, or run electrical systems without starting the aircraft, the ground power panel can be used once electrical power is requested from the ground crew. Once EXT PWR (External Power) is selected from the panel, four groups can be selected with each having sub A and B groups of instruments and systems being powered by the group.
2. **Fire Test Switch.** The fire/bleed air leakage detection sensors and associated circuits are tested by the fire and bleed air test switch. When actuated to TEST A or TEST B, the fire warning, bleed air leak detection and voice alert warning circuitry for the designated loop is tested. The switch must manually be held in the test position.
3. **Exterior Lighting Panel.** Three lighting controls comprise this panel:
 - **Position Lights.** The position lights include a white light just below the tip of the right vertical tail fin, three green lights on the right side of the aircraft, and three red lights on the left side of the aircraft. The position lights are controlled by the POSITION lights knob. The exterior lights master switch must be ON for the position lights knob to operate.
 - **Formation Lights.** Eight formation lights are provided. Two lights are on each wing tip and show above and below a wing tip missile when installed, two lights are on the outboard of the vertical tail fins, two lights are on the aft fuselage below the vertical tail fins, and two lights are on either side of the forward fuselage just forward of the LEX. The formation lights are controlled by the FORMATION lights control knob on the

- exterior lights panel which provides variable lighting between positions OFF and BRT. The exterior lights master switch must be ON for the formation lights knob to operate.
- **Strobe Lights.** Two red anti-collision strobe lights, one on each outboard vertical tail fin, are provided. The strobe lights are controlled by the STROBE lights switch on the exterior lights panel. The exterior lights master switch must be ON for the strobe lights switch to be operative.
 - OFF Lights are off.
 - BRT Lights illuminate at full intensity.
 - DIM Lights illuminate at reduced intensity.
 - 4. **APU and Engine Crank Panel.** The APU switch enables and disables the Auxiliary Power Unit. When the APU is operating normally, the green APU light next to the switch will illuminate. The Engine Crank switch has left and right positions and is moved to the respective side during engine start. See the Cold Start procedure of this guide.
 - 5. **Flight Control System (FCS) Panel.** On the left side of the panel is the rudder trim knob with can be rotated left and right to add rudder trim. In the center of the knob is the takeoff trim button which pressed to set the flight control surfaces to takeoff trim settings. On the right side of the panel is the FCS Reset button. This button is pressed in the event of an FCS failure in order to re-start the FCS channels.
 - 6. **Volume Panel.** This panel consists of eight knobs that can control the volume heard through the headset. For this Early Access version, the knobs for WPN (AIM-9 seeker), RWR (RADAR warning receiver), and TCN (TACAN) are functional.
 - 7. **Oxygen System Panel.** The Oxygen System panel includes control of the Onboard Oxygen Generation Systems (OBOGS). Controls include an ON/OFF switch and flow dial.

Along the left wall are the circuit breakers for FCS channels 1 and 2, as well as for the speed brake and launch bar. The large red button is the countermeasures dispenser button.

Right Vertical Panel

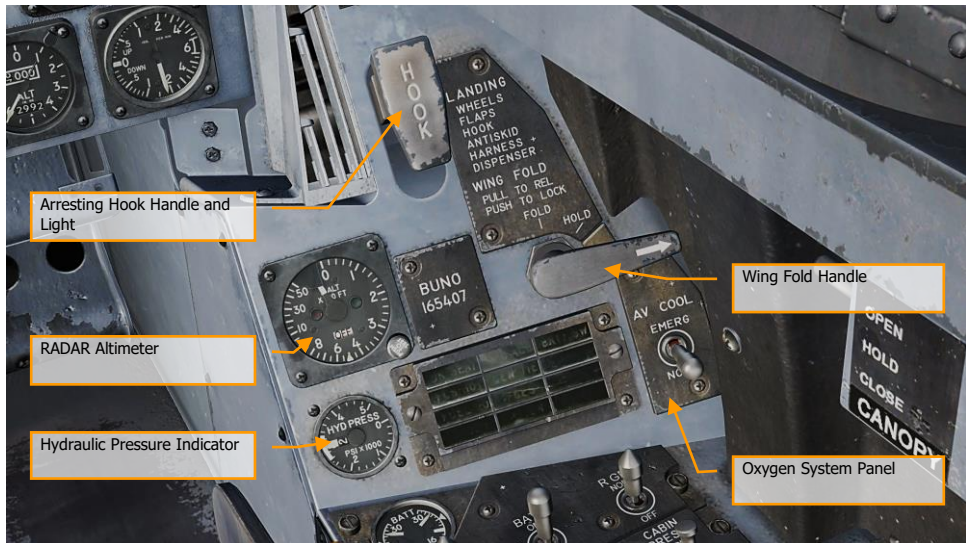

Figure 15. Right Vertical Panel

1. **Standby Magnetic Compass.** A conventional aircraft magnetic compass is mounted on the right windshield arch.
2. **Arresting Hook Handle and Light.** To extend the arresting hook, place the arresting hook handle down. The HOOK light comes on when the hook is in transit and goes out when the hook reaches the selected position. The light remains on if the hook is in contact with the deck and is prevented from reaching the hook down proximity switch. The HOOK light remains on any time the hook position does not agree with the handle position. Lower **[LCTRL + H]** and raise **[LCTRL + H]**
3. **Wing Fold Handle.** Normal folding and spreading the wings is accomplished through operation of the wing fold handle. To fold the wings, pull out and rotate counterclockwise to FOLD. The MASTER CAUTION light comes on. To spread the wings, rotate the wing fold handle clockwise to SPREAD. To lock the wings after they have fully spread, push the handle in. The wings can be stopped and held in any intermediate position by placing the wing fold handle to HOLD.
4. **RADAR Altimeter.** The RADAR altimeter set indicates clearance over land or water from 0 to 5,000 feet. The height indicator, on the instrument panel, consists of a calibrated scale from 0 to 5,000 feet, a push to test switch, a low altitude index pointer, an altitude pointer, an OFF flag, a low altitude warning light, and a BIT light. This is normally set at 200 feet for airfield operations and 40 feet for carrier operations.

5. **Hydraulic Pressure Indicator.** The left, or system 1, provides power to the primary flight control surface actuators exclusively. The right, or system 2, also provides power to the primary flight control actuators and additionally supplies power to the speed brake and non-flight control actuators.
6. **Right Warning / Caution Advisory Lights.** All lights on this panel are steady state, yellow lights.
 - **APU ACC.** Indicates that the APU accumulator pressure necessary for the starting the engine is inadequate.
 - **FUEL LO.** Indicates the fuel quantity remaining is below 800 pounds in either of the two feed tanks. FUEL LO will remain on for at least one minute for each fuel low occurrence to avoid repetitive occurrences due to fuel sloshing.
 - **L GEN.** Indicates that the left generator outputs has failed or is turned off.
 - **R GEN.** Indicates that the right generator outputs has failed or is turned off.
 - **BATT SW.** Battery switch is set to ON.
 - **FCS HOT.** The flight control computer and transformer/rectifier are undercooled. This is due to insufficient avionics cooling in the right hand equipment bay. In such a situation, the EMERG position on the FCS Cool switch should be selected.
 - **FCSES.** A function has been lost in one or more axis of the Flight Control Electronics Systems. Loss of one of the eleven flight control functions.
 - **GEN TIE.** GEN TIE switch set to RESET.
 - **CK SEAT.** Ejection seat has not been armed.

Right Console

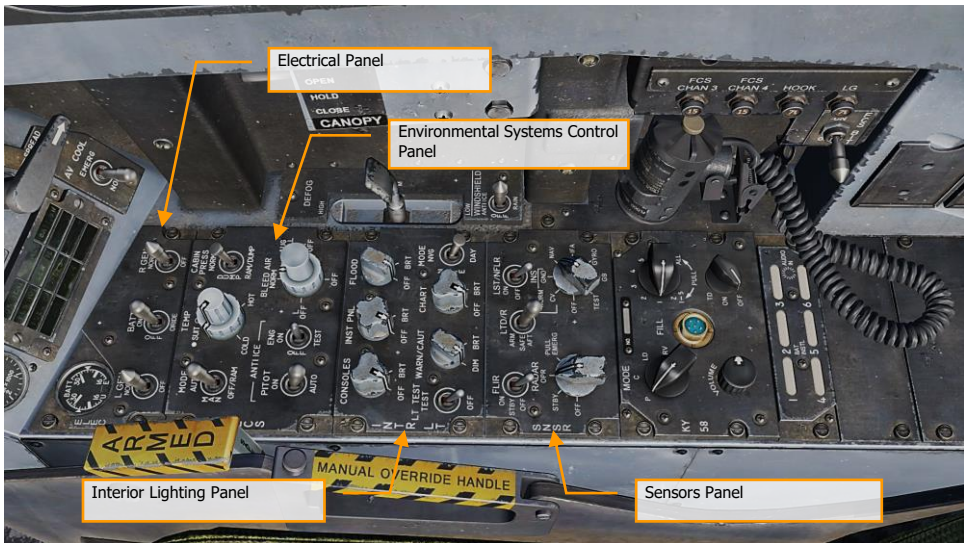

Figure 16. Right Console

1. **Electrical Panel.** The electrical (ELEC) panel has controls for both generators, the battery and its voltage meter.
 - **Left Generator Switch.** Used to enable or disable the left generator. This switch has two positions. NORM to enable normal operation and OFF to disable the generator.
 - **Right Generator Switch.** Used to enable or disable the right generator. This switch has two positions. NORM to enable normal operation and OFF to disable the generator.
 - **Batteries Voltmeter.** The voltmeter, which combines a U battery voltmeter and E battery voltmeter in one indicator, is on the electrical power panel. With the battery switch OFF, the voltmeters are inoperative and the indicator needles indicate 16 volts. With the battery switch ON both voltmeters are operative; with the switch in ORIDE only the E voltmeter is operative.
 - **Battery Switch.** The battery switch controls operation of the two onboard batteries and has three positions:
 - **OFF.** Batteries can be charged, but battery contactors will not energize to connect a battery to the essential bus in response to low voltage conditions.
 - **ON.** Enables control circuitry of both battery contactors so the U battery contactor will automatically close in response to a low voltage condition on the left 28 volt dc bus, and the E battery contactor will subsequently close in response to a low voltage condition from the U battery output and left 28 volt dc bus.

- **ORIDE.** Energizes E battery contactor regardless of charge status of U battery, providing voltage on left 28 volt dc bus is absent or low. Position can be used to connect E battery to the essential buses in the event U battery contactor fails to energize with switch in the ON position.
2. **Environmental Control System Panel.** The ECS panel controls that will be applicable to the Hornet Early Access include:
- **Bleed Air Select Switch.** This switch controls the bleed air source. Bleed air is automatically shut off if a leak is detected.
 - **BOTH.** Bleed airflow is provided to the ECS by both engines.
 - **R OFF.** Bleed airflow is provided to the ECS by only the left engine.
 - **L OFF.** Bleed airflow is provided to the ECS by only the right engine.
 - **OFF.** All bleed airflow from the engines is shut off. This includes ECS cooling, cabin pressurization, and warm air. Ram air is automatically used instead.
 - **AUG.** Allows the APU to augment bleed air pressurization of the cabin when the aircraft has weight on wheels and engine operating at less than intermediate settings.
 - **Engine Anti-Ice Switch.** This switch controls anti-ice heating of the engine inlets.
 - **ON.** Allows hot bleed air to circulate through the engine inlet and engine components.
 - **OFF.** Turns off engine anti-ice.
 - **TEST.** Triggers ice caution message.
 - **Pitot Heater Switch.** There are two pitot-static tubes mounted under the nose on each side forward of the nosewheel well. Each tube contains one pitot source and two static sources. The pitot heater switch on the ECS panel has positions ON and AUTO.
 - **AUTO.** Heaters are on when airborne.
 - **ON.** Heaters are on when ac power available.
3. **Interior Lighting Panel.** The interior light panel controls all illumination options and settings within the cockpit.
- **Console Lighting Knob.** Integral and light panel lighting for the left and right consoles, the hydraulic pressure indicator, and both cockpit circuit breaker panels are controlled by the CONSOLES knob which provides variable lighting between positions OFF and BRT. With the MODE knob in the NVG position, the CONSOLES knob provides variable NVG floodlighting between OFF and BRT for the consoles.
 - **Instrument Lighting Knob.** Integral and light panel lighting for the instrument panel, UFC background, right and left vertical panels (except for the hydraulic pressure indicator) and standby magnetic compass are controlled by the INST PNL knob which provides variable lighting between positions OFF and BRT. The strobe shoot light does not illuminate when the instrument lights are on. The INST PNL knob provides variable lighting between OFF and BRT, with the MODE switch in either NORM or NVG.
 - **Flood Lighting Knob.** Eight white floodlights are provided for secondary lighting. Three console floodlights are above each console, and an instrument panel floodlight is located to either side of the instrument panel. The FLOOD knob is inoperative with the MODE switch in the NVG position.
 - **Chart Lighting Knob.** A chart light is installed on the canopy arch. An NVG compatible chart light is controlled by the CHART knob and rotates in two axis with variable lighting

- between OFF and BRT. The chart light operates independent of the MODE switch position.
- **Lights Test Switch.** A lights test switch, labeled LT TEST, is provided to test the warning/caution/advisory lights in addition to the AOA indexer lights and the integrated fuel/engine indicator LCD displays.
 - **Warning and Caution Lights Knob.** A knob labeled WARN/CAUT is provided on the interior lights control panel to vary the brightness of the warning/caution/advisory lights within the low intensity range.
 - **Mode Switch.** The MODE switch has positions of NVG, NITE, and DAY. The DAY position permits the maximum brightness range for the warning, caution, and advisory lights and the main and console panel lighting. The NITE position provides reduced brightness for the warning, caution, and advisory lights, and normal intensity for the main and console lighting. The NVG position provides reduced brightness for the warning, caution, and advisory lights, disables the integral console lighting, and enables NVG compatible flood lights to illuminate the consoles.
4. **Sensors Panel.** At this Early Access stage, functionality of the sensor panels includes the RADAR knob and the INS knob. For the INS knob, place the knob in NAV for navigation functions.
- **INS Knob.** This eight-position rotary knob controls the inertial navigation system. For this Early Access release, the following positions operate:
 - **OFF.** Removes power from the INS.
 - **GND.** Places the INS in ground alignment.
 - **NAV.** Places the INS in navigation mode.
 - **RADAR Knob.** Four position rotary knob controls all operating power applied to the RADAR set.
 - **OFF.** Removes all RADAR set power.
 - **STBY.** Activates all components except for high voltage. Allows RADAR set to warm-up before application of high voltage, or, removes high voltage but maintains RADAR for immediate application of high voltage.
 - **OPR.** Commands RADAR to full operation if all safety interlocks have been satisfied and initial warm-up time is complete.

Along the right wall are the canopy control switch, the FCS BIT switch, and circuit breaks for the arrestor hook, landing gear and FCS channels 3 and 4.

Control Stick

The stick contains the pitch and roll trim switch, sensor control switch, Air-to-Ground bomb release button, gun/forward-firing weapons trigger, Air-to-Air weapon select switch, un-designate/nose wheel steering button. An autopilot/nose wheel steering disengage switch (paddle switch) is mounted below the stick grip. Stick position sensors transmit an electrical signal proportional to stick displacement from neutral to the flight control computers.

Several of the switches have multiple functions that depend on a selected mode. We will discuss those in the later, relevant sections of this Quick Start manual.

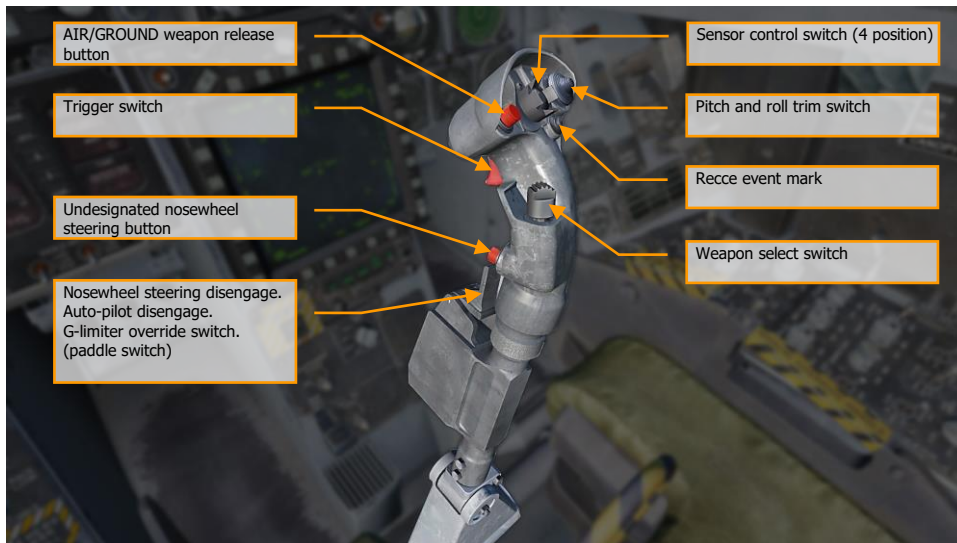

Figure 17. Control Stick

Throttles

The throttle grips contain switches that provide various systems control without moving the hand from the throttles. As with the Control Stick, the HOTAS functions of the Throttles vary in functionality depending on the state and operational modes of the aircraft. These are discussed in the appropriate sections of this document.

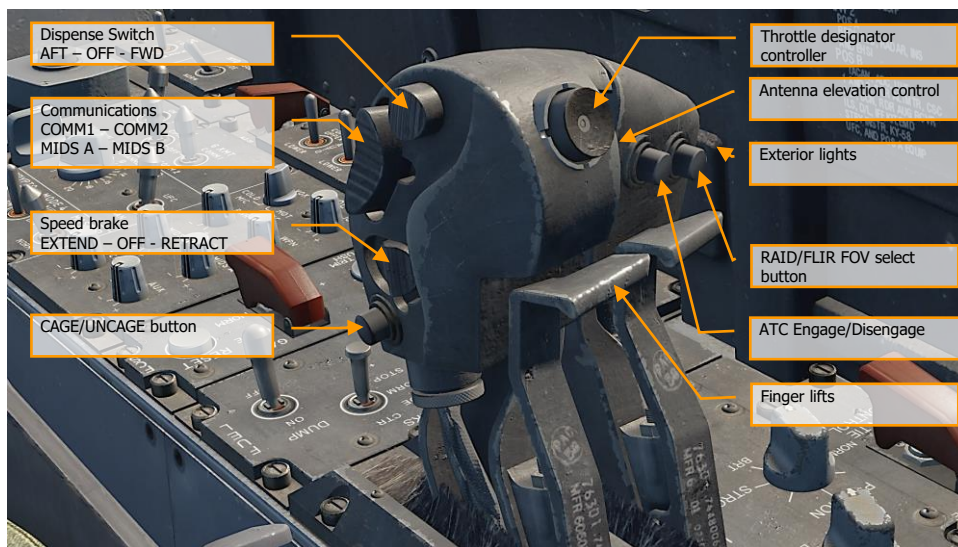

Figure 18. Throttles

DDI and AMPCD Pages

In addition to the physical controls of the Hornet cockpit, much of your interaction will be through the multitude of pages on the left and right Digital Display Indicators (DDI) and the central Advanced Multipurpose Color Display (AMPCD). The AMPCD is commonly referred to as just the MPCD.

Instant Action Mission Practice: Hornet Ready on the Ramp

Before we discuss common Hornet procedures, let's review some of the more important DDI and MPCD pages you'll use. Additional DDI pages will become functional during the Early Access period. There are two primary pages in which all other pages are selected from: The Support (SUPT) page and the Tactical (TAC) page. You can toggle between these pages, or return to them, by pressing the pushbutton marked MENU. When airborne, the MENU pushbutton converts to a timer, but still acts as a MENU button.

Support (SUPT) Pages



Figure 19. Support (SUPT) Pages

Built In Test (BIT) Page. The Hornet consists of a numerous sub systems, each with has its own built in test system. This page allows the pilot to test these systems and view their status.



Figure 20. BIT Page

Check List (CHKLST) Page. In addition to providing checklists for landing and takeoff, this page also displays aircraft weight and stabilator position.

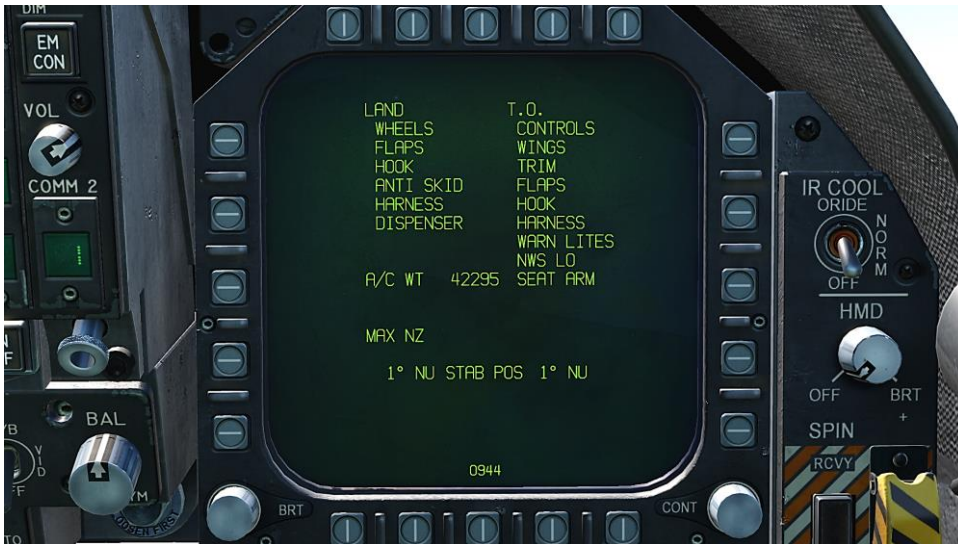

Figure 21. Checklist Page

Engine (ENG) Page. The Engine page provides important engine performance data for both engines, which often duplicates engine data on the IFEI such as engine RPM, engine temperature, fuel flow, and oil pressure. Most often though, you will be using the IFEI to check engine performance.



Figure 22. Engine Page

Flight Control System (FCS) Page. The FCS page displays monitoring data of the flight control surfaces like the leading and trailing edge flaps, ailerons, rudders, and stabilator. It will also note any FCS errors noted in the four channels as "Xs". This page also displays the G limit based on aircraft gross weight.



Figure 23. Flight Control System (FCS) Page

Fuel (FUEL) Page. The Fuel page duplicates much of the fuel information displayed in the IFEI, but provides additional information on the fuel quantity of individual fuel tanks.



Figure 24. Fuel Page

Electronic Attitude Director Indicator (EADI) Page. The EADI page provides a digital representation of the aircraft's pitch, roll, and yaw attitude. The EADI also displays aircraft airspeed and altitude in the top left and right corners.



Figure 25. Electronic Attitude Director (EADI) Indicator

Horizontal Situation Indicator (HSI) Page. Mostly displayed on the MPCD, the HSI provides a top-down navigation display with your aircraft in the center. The HSI will be discussed later in the navigation portion of this guide.



Figure 26. Horizontal Situation Indicator (HSI) Page

Tactical (TAC)



Figure 27. Tactical (TAC) Pages

Electronic Warfare (EW) Page. The EW page combines the display of detected radar emitters, control of Electronic Countermeasures (ECM), and control of expendable countermeasure that includes chaff, flares, and ECM decoys.



Figure 28. EW Page

Head Up Display (HUD) Page. The HUD page duplicates what is displayed on the HUD glass at the top of the instrument panel. This is most often used when the HUD fails or is unreadable due to lighting. It can also be useful when “head down” and not being able to easily check the HUD.



Figure 29. Head Up Display (HUD) Page

Attack RADAR (RDR) Page. For this initial version of the Hornet Early Access, this page will display air-to-air RADAR. Please see the RADAR section of this guide for details.

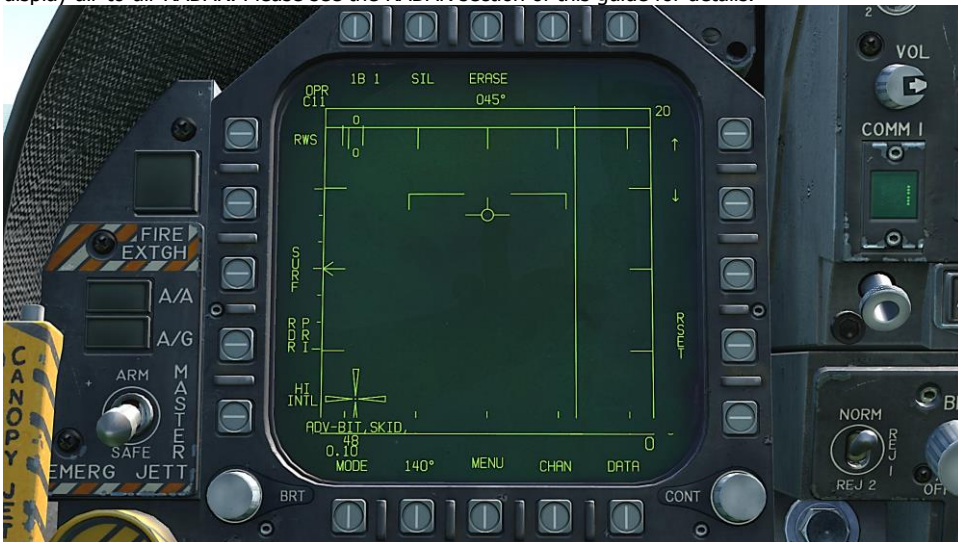

Figure 30. Attack RADAR Page

Stores Management System (SMS) Page. The SMS page allows you to view all loaded stores and determine their delivery properties. We will discuss this page in detail in the weapon procedure sections of this guide.



Figure 31. Stores Management System (SMS) Page

HEAD UP DISPLAY

The Head Up Display, or HUD, is one of your most important instruments and provides valuable information as to your aircraft flight performance and weapon / sensor information. In later sections of this guide we will discuss aspects of the HUD that are specific to certain weapons and sensors, but the HUD does have a common set of information that is almost always displayed.

Instant Action Mission Practice: Hornet Ready on the Ramp

The HUD as pictured below is independent of aircraft Master Mode with the exception of the bank angle scale, vertical velocity, and heading scale.

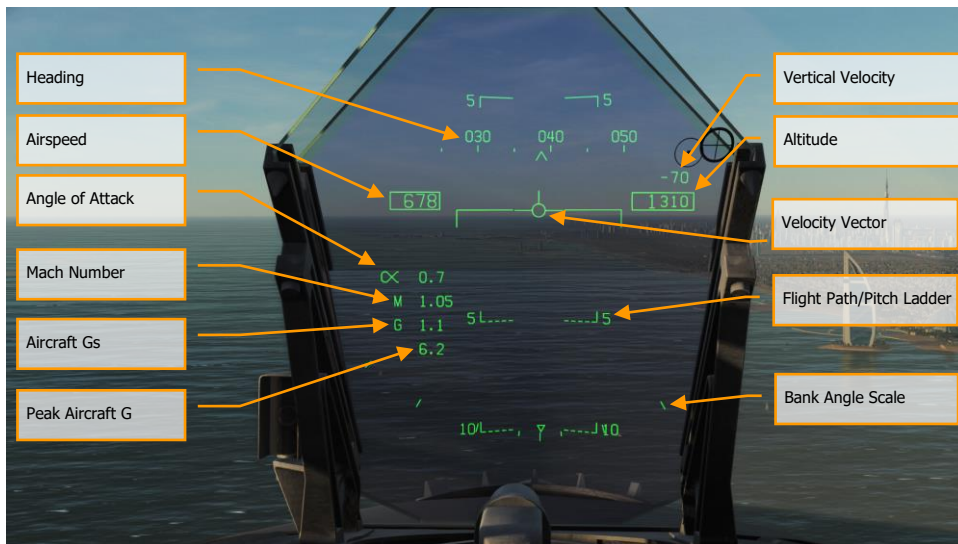

Figure 32. Basic HUD Information

1. **Heading.** This 30 degree, moving heading scale displays the aircraft's magnetic or true heading (set in HSI/DATA). The aircraft's heading is indicated as the caret in the center of the scale. When True heading is selected, a "T" is placed below the heading caret.
2. **Airspeed.** Calibrated airspeed as determined by the Air Data Computer (ADC).
3. **Vertical Velocity.** Positive or negative aircraft altitude change in feet per minute.
4. **Altitude.** Barometric or RADAR altitude in feet as set by the ALT switch on the HUD control panel. When RADAR altitude is selected, an "R" is displayed next to the altitude

box. If however the RADAR altitude is invalid, a flashing "B" is displayed to indicate that barometric altitude is being used instead.

5. **Angle of Attack.** True angle of attack in degrees of the aircraft.
6. **Mach Number.** Aircraft speed as Mach airspeed.
7. **Aircraft Gs.** Normal acceleration value of the aircraft.
8. **Peak Aircraft G.** Maximum achieved G over 4 G's.
9. **Velocity Vector.** Represents the point toward which the aircraft is flying along the aircraft's actual flight path. When not displaying accurate information, the symbol will flash. The Velocity Vector can be caged and uncaged to the center of the HUD with the cage/uncage button on the throttle.
10. **Flight Path/Pitch Ladder.** The vertical flight path angle of the aircraft as indicated by the position of the Velocity Vector on the Flight Path/Pitch Ladder. The aircraft's pitch angle is indicated as the aircraft waterline on the Flight Path/Pitch Ladder.
11. **Bank Angle Scale.** With marks at 5, 15, 30 and 45 degrees, rolling the aircraft to place the center caret in relation to these marks provides a bank angle reference.

Barometric Setting. The barometric altitude is displayed below the altitude box for five seconds when the barometric altitude is changed on the standby altimeter. It will also display if the aircraft is below 10,000 feet and at an airspeed less than 300 knots if previously above both values.

Ghost Velocity Vector. When the Velocity Vector is caged, the Ghost Velocity Vector is displayed and shows the true velocity vector of the aircraft.

PROCEDURES

In the following sections, we will provide “How To” checklists for the primary procedures you’ll need to understand to get started in the Hornet.

Instant Action Mission Practice: Hornet Cold and Dark

Cold Start

There are two methods you can use to start a cold and dark Hornet. The first, and easiest, is the Auto-Start. By pressing [\[LEFT WIN + HOME\]](#), the aircraft will be started automatically for you. To cease the Auto-Start, you can press [\[LEFT WIN + END\]](#).

Being a DCS title though, the Hornet really shines when you take advantage of the detailed systems modeling, like manually starting the aircraft. As an Early Access Guide, we will skip the pre-flight check list and go straight to starting up the aircraft to the point of being ready to taxi.



1. Set the BATTERY switch to ON and confirm both Left and Right Generators are ON. [\[RIGHT CONSOLE\]](#)
2. Move and hold the fire detection switch to FIRE TEST A and wait for all of the audio caution messages to play. Once complete, wait 10 seconds and then do the same for FIRE TEST B. Between running FIRE TEST A and FIRE TEST B, you can reset the battery switch to rewind the fire test tape. [\[LEFT CONSOLE\]](#)

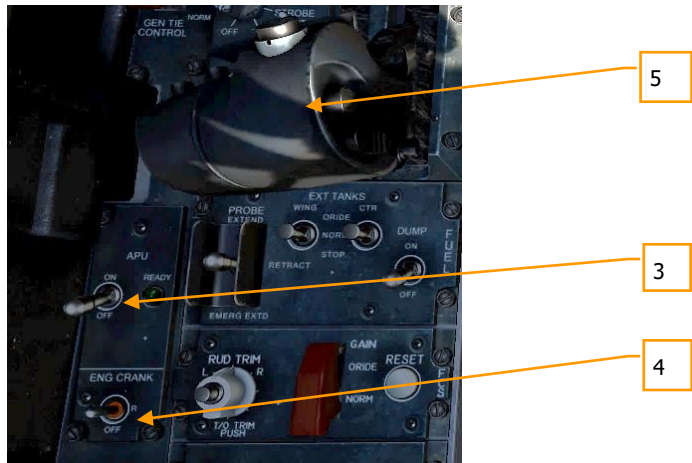

3. APU switch to ON and wait for green APU READY light. [|LEFT CONSOLE|](#)
4. Move the ENG CRANK switch to the right to start the right engine. [|LEFT CONSOLE|](#)
5. Move the right throttle from OFF to IDLE when the right engine is above 25% rpm (as shown on IFEI). [|LSHIFT + HOME|](#)
6. Once right engine RPM is over 60%, rotate the BLEED AIR knob 360 degrees clockwise, from NORM to NORM. [|RIGHT CONSOLE|](#)
7. Test the CAUTION, WARNING and ADVISORY lights test. [|RIGHT CONSOLE|](#)

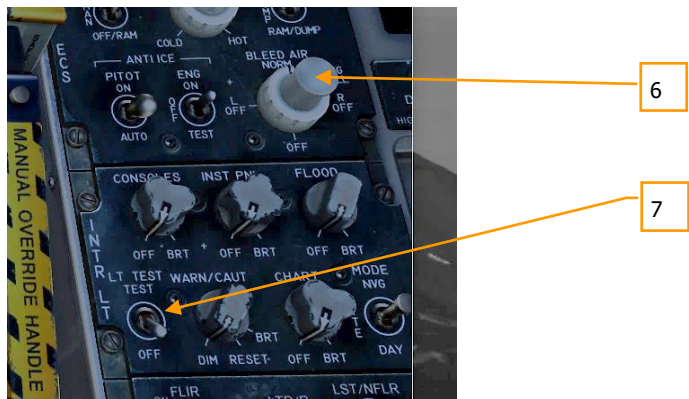

8. Turn on the power to both DDIs, MPCD and HUD. Select the FCS page on the left DDI and the BIT page on the right DDI. [|INSTRUMENT PANEL|](#)



9. Set COMM 1 and COMM 2 radios as required for the mission.

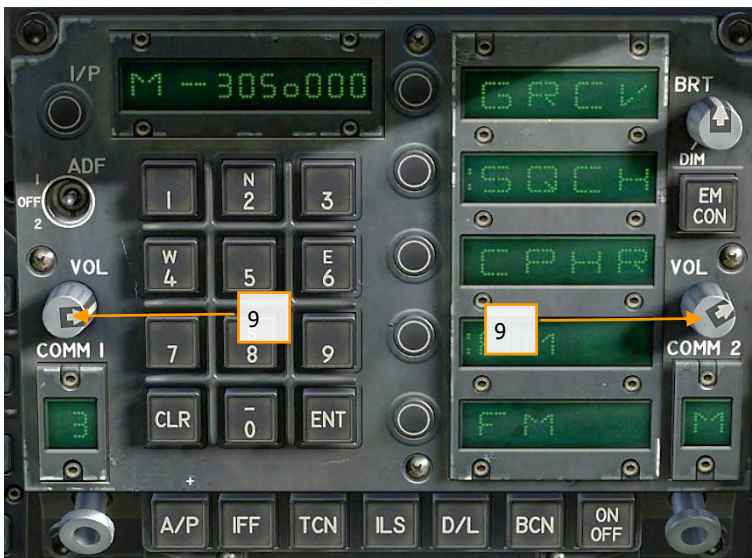

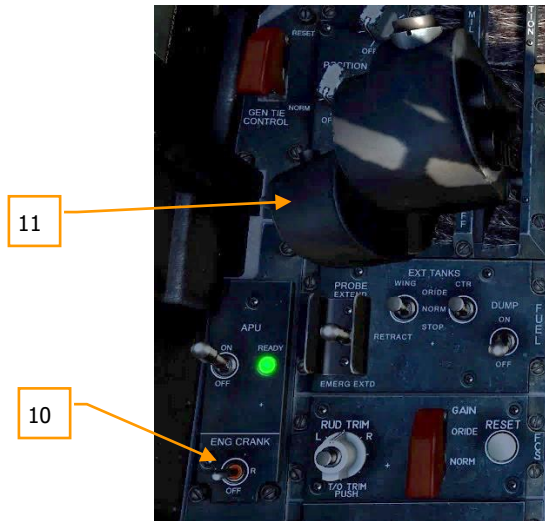

10. Move the ENG CRANK switch to the left after confirming that the right engine has an rpm between 63 and 70%, a TEMP between 190 and 590 degrees, Fuel Flow between 420 and 900 PPH, a nozzle position between 73 and 84%, and an OIL pressure between 45 and 110 psi. [|LEFT CONSOLE|](#)
11. Move the right throttle from OFF to IDLE when left engine has reached at least 25% rpm by pressing [\[RIGHT ALT + HOME\]](#). [|THROTTLES|](#)



12. Once the left engine has an RPM greater than 60%, rotate the INS knob to GND (ground) or CV (carrier), depending on your parking location. [RIGHT CONSOLE](#)
13. Set the RADAR knob to OPR (operate). [RIGHT CONSOLE](#)
14. Set the OBOGS control switch and FLOW switch to ON. [LEFT CONSOLE](#)



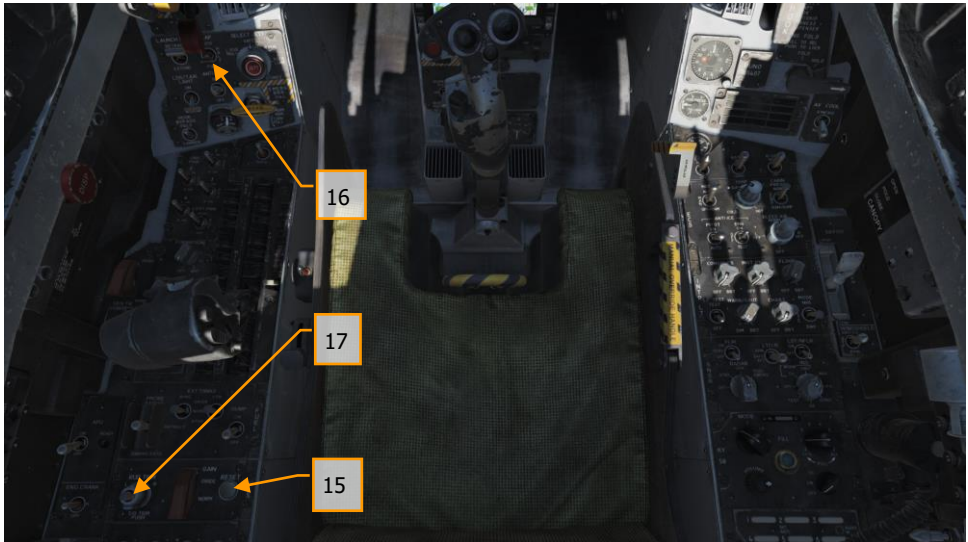

15. Press the FCS RESET button and monitor FCS DDI page. [|LEFT CONSOLE|](#)
16. Set the Flap switch to AUTO. [|LEFT QUARTER PANEL|](#)
17. Press Takeoff Trim button. [|LEFT CONSOLE|](#)
18. While holding up the FCS BIT switch [Y] on the right wall, press the FCS OSB on the BIT / FCS page at the same time.



19. Four down test. Cycle / test the refueling probe, speed brake, launch bar, arrestor hook, pitot heat, and set flaps to HALF. [\[LEFT CONSOLE, THROTTLES, LEFT QUARTER PANEL, RIGHT QUARTER PANEL, and RIGHT CONSOLE\]](#)
20. Left mouse click on the hand brake to release it.



21. Set your BINGO fuel level (minimum fuel to return home) by pressing the up and down arrows on the IFEI. [|LEFT INSTRUMENT PANEL|](#)
22. Set the Standby Barometric Altimeter to airfield elevation. [|RIGHT INSTRUMENT PANEL|](#)
23. Set the RADAR Altimeter to 200 feet for an airfield takeoff or 40 feet from the carrier. [|RIGHT QUARTER PANEL|](#)
24. Uncage the standby Attitude Indicator. [|RIGHT INSTRUMENT PANEL|](#)
25. Set the Attitude Source to STBY (standby). [|CENTER INSTRUMENT PANEL|](#)

Taxi

For the purposes of this Early Access Guide, we will cover the taxi and takeoff procedures when operating from an airfield. The full manual will detail aircraft carrier operations.

1. Whether you have completed a cold start or are starting the mission in a "hot" aircraft, your next step will be to taxi to the runway. Slowly advance the throttles [|PAGE UP|](#) and use the rudder pedals to steer left [|Z|](#) and right [|X|](#). Reduce throttle by pressing [|PAGE DOWN|](#). Holding down the Noses Wheel Steering (NWS) button, you can enable NWS HI mode enabled tighter taxi turns. Press [|W|](#) to apply wheel brakes.
2. Set the left DDI to the checklist page and the right DDI to the FCS page.
3. At the hold short before entering the active runway:

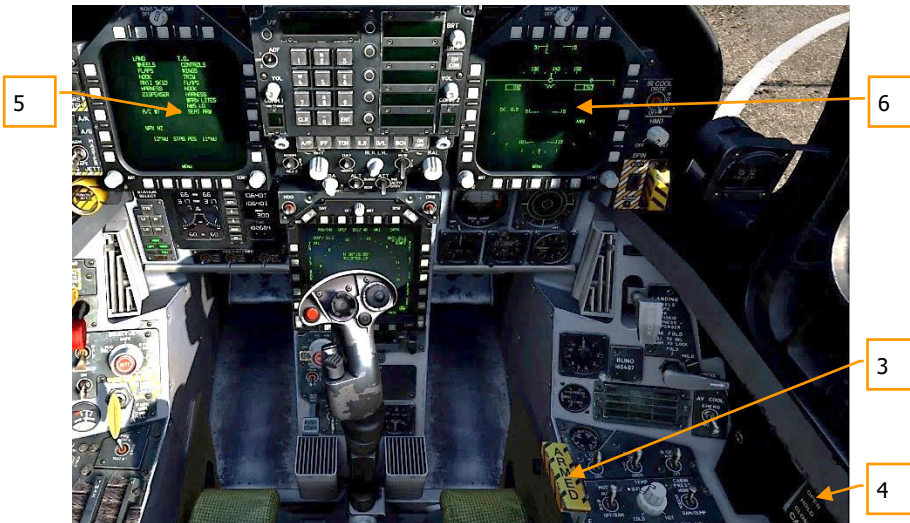

4. Arm the ejection seat. [|RIGHT CONSOLE|](#)
5. Close the canopy if you have not already done so. [|RIGHT CONSOLE|](#)
6. Set the left DDI to the HUD page. [|LEFT INSTRUMENT PANEL|](#)

Normal Takeoff

Instant Action Mission Practice: Hornet Takeoff

1. Align the aircraft down the center of the runway and roll forward to align the nosewheel down the runway.
2. Set left DDI to the HUD page.
3. Advance to throttles to afterburner.
4. Use nosewheel steering to maintain a straight track down the runway.

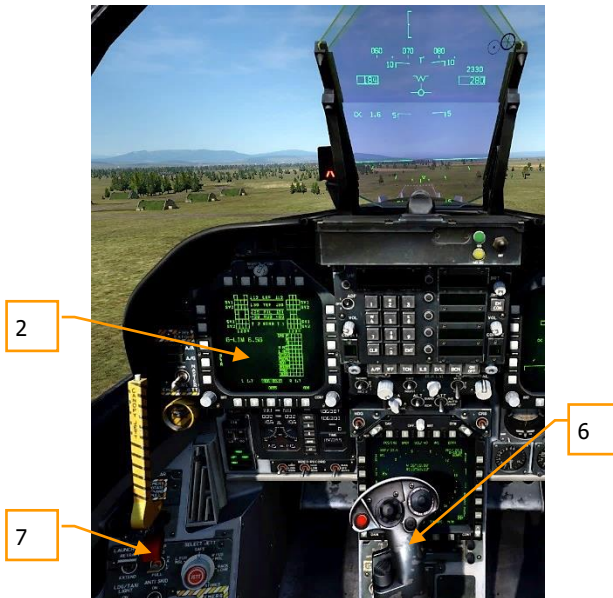

5. At nosewheel rotation speed, hold the control stick back until 6 to 8 degrees nose high attitude (water line above the horizon line on the HUD)
6. Raise the landing gear and set the FLAP switch to AUTO once positive climb is established.
7. Switch the right DDI to air-to-air RADAR.

Landing

Being aircraft carrier capable aircraft, the Hornet can land on both “the boat” and airfields. Both landing patterns are quite similar. For this guide though, we will just review the procedure for landing at an airfield. The full manual will cover aircraft carrier operations.

Instant Action Mission Practice: Hornet Airfield VFR Landing

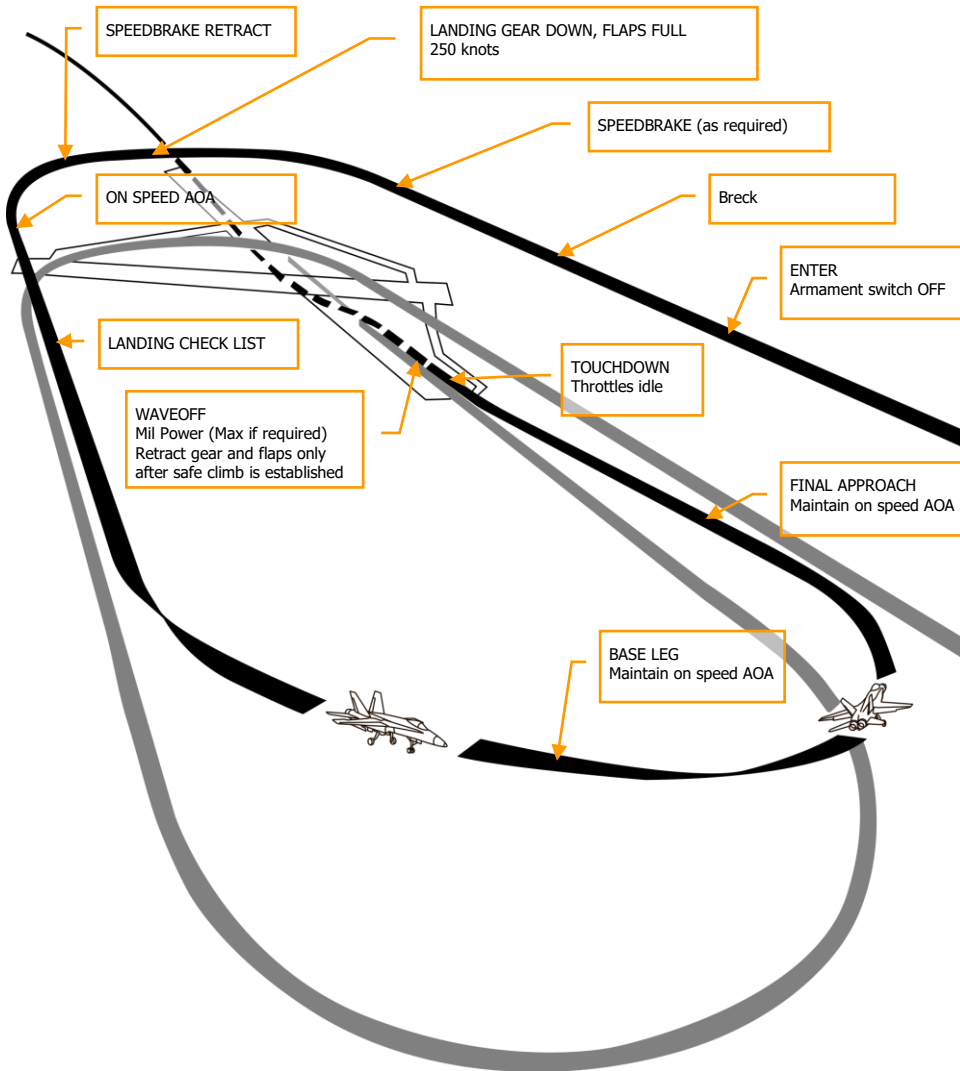
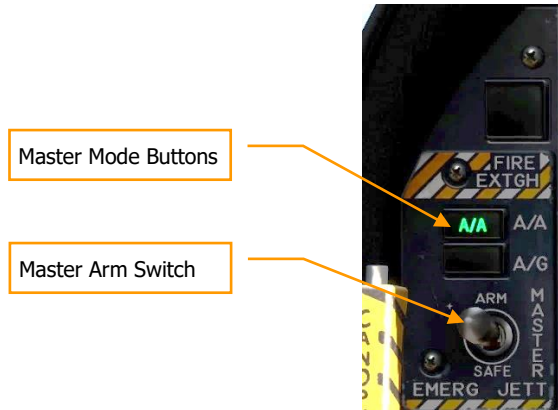

Figure 33. Airfield Landing Pattern

Call up the air-to-air RADAR page on your right DDI and HUD repeater on your left DDI.

Enter Navigation master mode and set the Master Arm Switch to SAFE on the [LEFT INSTRUMENT PANEL](#) and approach at 350 knots and 800 feet Above Ground Level (AGL) along the heading of the landing runway and offset yourself slightly away from your first turn into the pattern.



Five to ten seconds after your wingtip passes the end of the runway (the greater the time, the more time you have to establish your on-speed AoA on the downwind leg), turn into the downwind leg of the landing pattern. Generally, pull 1% of your airspeed in G. For example: 350 knots would equal 3.5 G. Roll out on a reciprocal landing heading and an altitude of 600 feet AGL.

Your lateral offset from the runway should be about 1.2 miles.

Once your airspeed is below 250 knots, lower your landing gear and place your flaps in the FULL down position. [LEFT QUARTER PANEL](#)



Landing Gear Handle

Flap Switch

Allow your airspeed to decay until you reach your on-speed angle of attack as indicated left of the HUD on the Angle of Attack Indexer. This will equate to 8.1 degrees of angle of attack which will appear as the yellow circle on the AoA Indexer. On the HUD, the Velocity Vector should be centered in the AoA "E" Bracket. Establish your on-speed AoA at 600 feet AGL.

You will need to trim the aircraft to 8.1 degrees to be hands-free.



Turn into the landing base leg when your wing tip aligns with the runway threshold while maintaining on-speed AoA. Your bank angle should be 30 degrees and the HUD velocity vector should be just below the HUD horizon line. You will need to slightly increase throttle to maintain this AoA. Continue the on-speed descending turn until you are aligned with runway landing heading (a good idea is to set your course line to the landing airfield along the landing runway heading).

Maintain on-speed AoA with the HUD velocity vector placed 500 feet past the runway threshold. Use your throttle to maintain a 3 degree flight path.

At touchdown, reduce the throttles to idle and use small rudder corrections to stay aligned down the runway roll-out.

HORNET COMMUNICATION SYSTEM

The DCS: F/A-18C Hornet is equipped with two ARC-210 (RT-1556) radios. These act as COMM 1 and COMM 2 and operate as both VHF and UHF radios for air-to-air and air-to-ground voice communications, in addition to Automatic Direction Finding (ADF).

Up to 20 channels in the 30 to 400 MHz band can be set as pre-assigned frequencies for each radio. Guard frequency operates at 243.00 AM. Preset frequencies are set in the Mission Editor, but can be manually edited while in flight.

To radio transmit on COMM 1 or COMM 2, the radio switch on the throttles must be pressed to the selected radio (1 or 2).

Instant Action Mission Practice: Hornet Ready on the Ramp

How to Use the Radios

1. Select desired radio preset frequency by rotating either the COMM 1 or COMM 2 knob. The frequency preset will be displayed on the Scratchpad.
2. Press COMM 1 or COMM 2 on the radio switch on the throttles based on radio the frequency is tuned to.
3. Use the Radio Menu to issue your radio message.

UFC Radio Functions

Primary control of the radios is done with the Upfront Control (UFC) include:

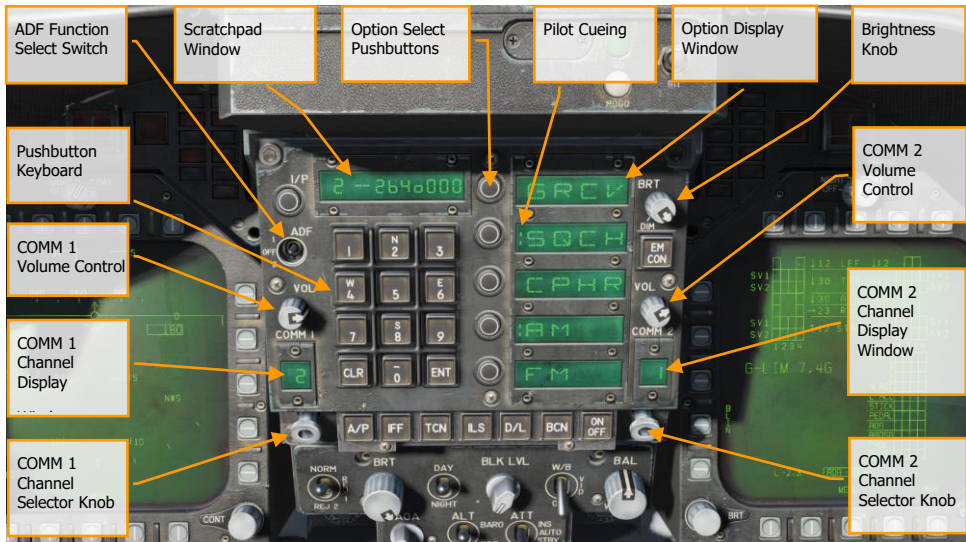

Figure 34. UFC Radio Functions

COMM 1 and COMM 2 Volume Control. Rotate these two knobs to control radio volume of the two radios.

COMM 1 and COMM 2 Channel Selector Knobs. When either knob is pulled, the active frequency is displayed on the Scratchpad Window. When rotated, they cycle through each of their 20 preset channels. Additionally, manual frequency selection mode (M), guard channel (G) at 121.5 Mhz for VHF and 243.0 for UHF, cue channel (C), and maritime (S) are available.

When Manual (M) is selected, the UFC keypad can be used to enter a frequency without having to overwrite an existing preset.

COMM 1 and COMM 2 Channel Display Windows. These two windows display the selected preset channel (1-20) and the G, M, C and S channels.

ADF Function Switch. This switch enables ADF steering on a selected radio beacon. When ADF 1 is selected, ADF steering is based on the COMM 1 radio setting. When set to ADF 2, ADF steering is in regards to the COMM 2 frequency. The OFF setting disables ADF steering.

ADF steering is indicated on the Horizontal Situation Indicator (HSI) as a small circle. See Navigation section of this guide.

Scratchpad Window. The selected radio preset or G, M, C, and S frequency are displayed on the Scratchpad, by either pulling either COMM knob or rotating the knob. The Scratchpad is also used to enter a frequency using the Manual entry (M) mode.

Option Display Windows. When a preset or G, M, C, S frequency is selected, options are displayed on the Option Display Windows in the center of the UFC. These include:

- **GRCV.** When selected and colon is visible, Guard is enabled. Guard is disabled when the colon is absent.
- **SQCH.** With colon visible, radio squelch is enabled to reduce the level of radio noise. With no colon displayed, squelch is disabled.
- **CPHR.** No function for this Early Access version.
- **AM.** Colon indicates that AM modulation is selected.
- **FM.** Colon indicates that FM modulation is selected.

Option Select Pushbuttons. These buttons are used to select the options indicated in the Option Display Windows.

Brightness Control Knob. Rotating this knob controls the brightness of the UFC display.

HORNET MASTER MODES

The Hornet has three master modes of operation: Navigation (NAV), Air-to-Air (A/A), and Air-to-Ground (A/G). The controls, displays and avionics equipment operations are tailored as a function of the selected master mode. A/A master mode is entered by either pressing the A/A master mode button or by selecting an A/A weapon with the Weapon Select Switch. When A/A is selected, the RADAR display is placed on the right DDI and the Stores Management System (SMS) display is placed on the left DDI. A/G master mode is selected by pressing the A/G master mode button. When neither master button is enabled (neither button lit), the Hornet is in the NAV master mode.

Before using the Hornet navigation system, enable the system by placing the INS knob on the Sensor Panel to the NAV position. [\[RIGHT CONSOLE\]](#)

HORNET NAVIGATION (NAV)

Navigation systems of the Hornet includes an Inertial Navigation System (INS) waypoints, Tactical Air Navigation (TACAN), Automatic Direction Finding (ADF), and Instrumented Carrier Landing System (ICLS). Together, these systems provide accurate navigation day or night and in all weather conditions. The primary navigation indicator is the Horizontal Situation Indicator (HSI) which is most often displayed on the central MPCD. A moving map can also be enabled with full-color capability on the MPCD and monochrome on the DDIs. The UFC is used for navigation data entry.

Instant Action Mission Practice: Hornet VFR Navigation

The primary methods of navigation are the TACAN mode which provides steering to navigation beacons and Waypoint based navigation points created in the Mission Editor or while in the cockpit. Both modes provide DATA pages for each TACAN station or waypoint, bearing and range to the location, time to reach the location, and various steering aids.

How to Navigate Using Waypoints

1. Select HSI from the SUPT DDI page
2. Select the WYPT Option Select Button
3. Use the Up and Down arrows to select waypoint as indicated between the arrows
4. Fly to the waypoint based on HSI and HUD command steering indicators

Regardless of navigation method, the HSI has the following options and indicators. Option buttons for the main HSI include:

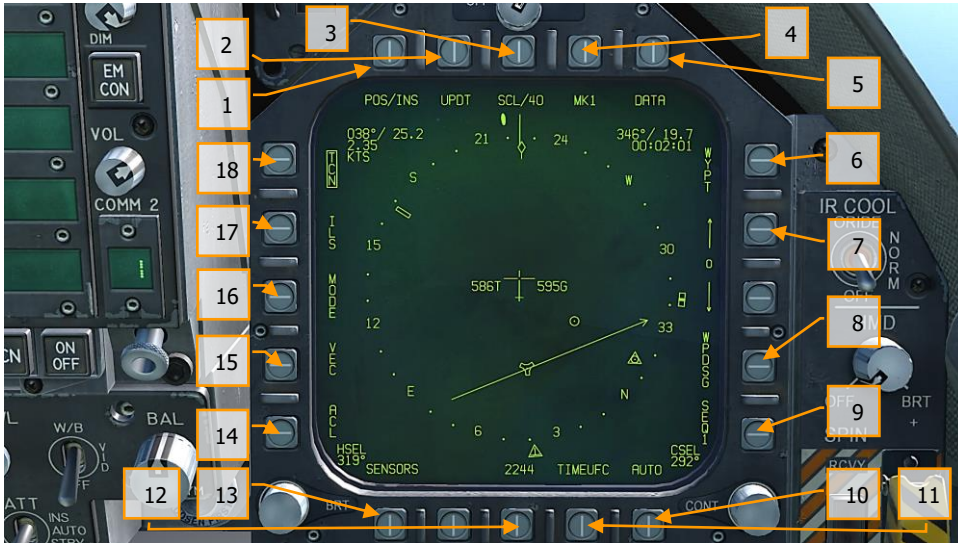

Figure 35. HSI Option Buttons

1. **POS/XXX Option.** The POS Option button determines the position keeping source. Pressing this Option Button displays the four options along the top of the DDI with an HSI option button to return to the main HSI page without making a change. The selected source is displayed as POS/(selected source).



Figure 36. Position Keeping Source Selection

2. **UPDT Option.** No function in this Early Access version.
3. **SCL Option.** This options allows selection of the range scale of the HSI. Successive presses of this button select and then wrap ranges of 5, 10, 20, 40, 80, and 160 miles. The selected scale is indicated right of the SCL legend.
4. **MK Option.** Pressing the MK option button saves a mark point at the location of the aircraft when the button is pressed. Up to nine mark points can be created. After the

ninth, the first mark point will be over-written and so forth. Not implemented at Early Access release.

5. **DATA Option.** With either TCN or WYPT selected as the navigation method, pressing the DATA button will display a sublevel with additional information about the aircraft, selected TACAN and selected Waypoint. See DATA section below.
6. **WYPT Option.** When selected and box, steering information is presented in regards to the selected waypoint. See Waypoint Navigation.
7. **Waypoint / Mark Point Selection.** The number between the two arrows is the selected waypoint, and the up arrow selects the next waypoint in the waypoint sequence and the down arrow selects the previous waypoint. At the end of the waypoint sequence, mark points are available in sequence.
8. **WPDSG Option.** Pressing the WPDSG designates the current navigation point as a target waypoint (TGT). When a waypoint is designated as a target, the WPDSG legend is removed and the WYPT legend changes to TGT. HUD symbology also reflects the change to be a target location.
9. **SEQ # Option.** When selected and boxed, all waypoints of the sequence are displayed on the HSI and dashed lines connect them in sequence. The dashed lines are removed when the map is slewed. Successive presses of this button cycle through the sequences. The Hornet can store three sequences.
10. **AUTO Option.** When selected and boxed, automatic sequence steering to the next waypoint is enabled. WYPT must be selected as the navigation method.
11. **TIMEUFC Option.** Selecting this options allows time selection options from the UFC. These include SET, ET (elapsed time) and CD (count down). Upon selecting (boxing) this option button, the UFC lists the time options to display on the HSI and HUD.



Figure 37. TIMEUFC Options on UFC

SET. Displays the date.

ET. Starts incrementing time in minutes and seconds up to 59:59. Press the UFC ENT button to start the counter and successive presses of the ENT button will pause and start the counter.

CD. The countdown timer starts to decrement time in minutes and seconds, starting from 06:00. Upon selection of the CD option, pressing the ENT button starts the timer and successive presses of the ENT button pauses and start the counter.

ZTOD. When selected, the zulu time of day is displayed.

LTOD. When selected, the local time of day is displayed.

Note that ET and CD are mutually exclusive and ZTOD and LTOD are mutually exclusive.

12. **MENU Option.** Displays the TAC menu page.
13. **SENSORS Option.** When enabled, aerial targets detected by the RADAR in range and azimuth are displayed on the HSI.
14. **ACL Option.** No function for this Early Access version.
15. **VEC Option.** No function for this Early Access version.
16. **MODE Option.** Pressing the MODE option button displays sublevel options along the left side of the HSI. These include T UP (HSI is oriented to the flight track is always pointed towards the top of the HSI display), N UP (true north is always at the top of the display), DCTR (de-center placed the aircraft symbol at the bottom of the display), MAP (enable or disable moving map), and SLEW (slew map with TDC when TDC assigned to the display).
17. **ILS Option.** No function for this Early Access version.

18. **TCN Option.** TACAN is selected as the navigation method. See TACAN Navigation

Waypoint Navigation

Waypoint navigation consists of a series of navigation points to create a navigation sequence. This allows point-to-point steering along the sequence using automatic (AUTO) sequencing. Any waypoint can also be designated as a target point (TGT) using the WPDSG option. Additionally, up to nine mark point can be created that can also act as waypoints. Command heading, distance, and time to reach the selected waypoint is provided on the HSI Waypoint Data Block and HUD.

Waypoint steering is selected by pressing the WYPT option button on the right side of the HSI. Below are increment and decrement arrows to select the steer-to waypoint as indicated between the arrows.

In the top right of the HSI, the bearing to, distance to and time remaining to reach the selected waypoint are displayed in the Waypoint Data Block. Inside the compass rose, the waypoint bearing indicator and waypoint symbol provide heading steering information.

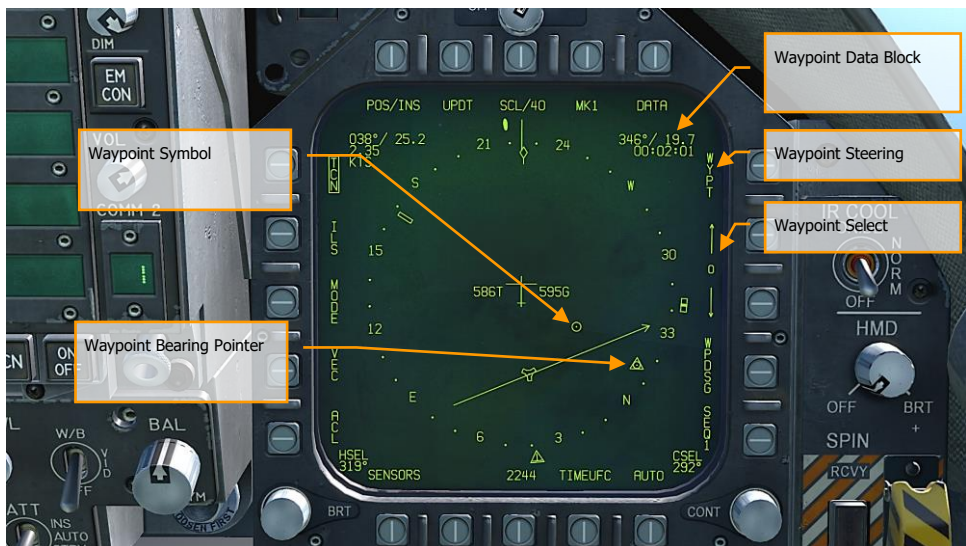

Figure 38. HSI Waypoint Steering

Additional waypoint steering is provided on the HUD.

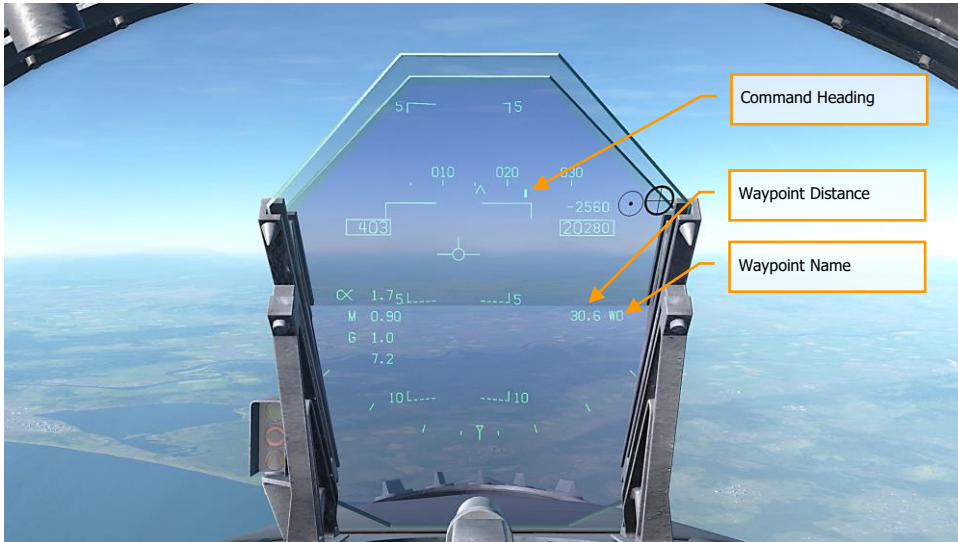

Figure 39. Waypoint Steering on HUD

While in waypoint navigation steering and a waypoint selected, the WPDSG (waypoint designate) option button on the right side of the HSI can be pressed to change the selected waypoint to a target point. On the HUD, the target appears as a Target Designation diamond which can be slewed with the TDC when the TDC is assigned to the HUD.



Figure 40. Waypoint as Target on HUD

TACAN Navigation

The ARN-118 TACAN system provides relative bearing and/or slant range distance to a selected TACAN station (land, ship or aircraft). TACAN range depends on aircraft altitude Line Of Sight (LOS) to the station, but can have a maximum range of 200 miles for an airborne station and 390 miles for a surface station. Each TACAN station has a three letter identifier which is used to identify the beacon and is displayed on the HSI and HUD when using TCN steering.

To use TACAN steering:

- 1- Select TCN from the UFC
- 2- Press X or Y of the desired channel from the UFC Option Select Window / Button
- 3- Turn on the TACAN by pressing the ON/OFF button on the UFC
- 4- Press CLR (Clear) on the UFC keypad to clear the scratchpad
- 5- Using the UFC key pad, enter the desired TACAN channel and then press the ENT button on the UFC
- 6- Select TCN on the HSI display



Figure 41. TACAN Options on UFC

TACAN modes from the UFC include:

- **T/R** (Transmit / Receive). Computes bearing and measures slant range from the selected TACAN station.
- **RCV** (Receive Only). Only bearing information from the selected TACAN station is computed.
- **A/A** (Air-to-Air TACAN). Computes range for up to five airborne TACAN stations.
- **X**. Selects the X channel option.
- **Y**. Selects the Y channel option.

With TACAN steering selected with a valid TACAN station channel, steering to the selected station is provided on both the HSI and HUD as follows:

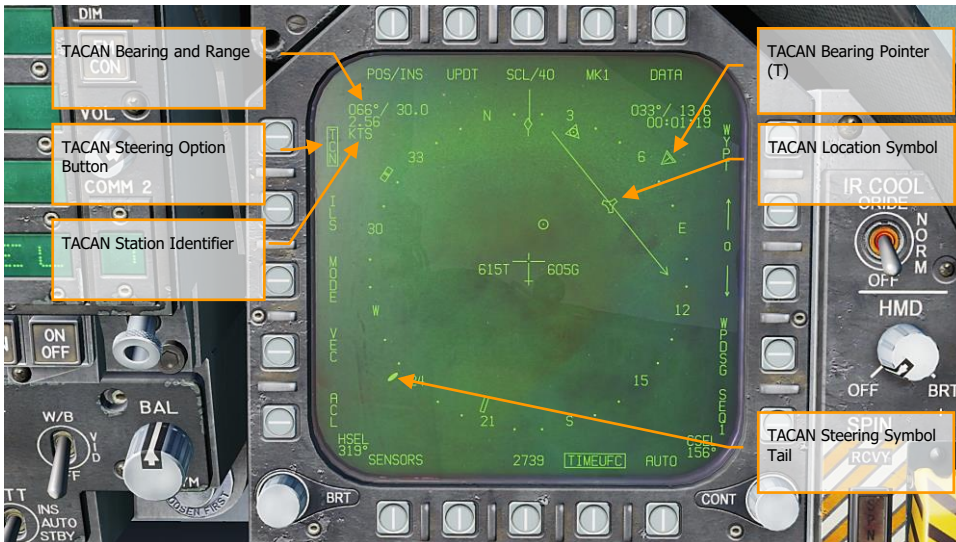

Figure 42. TACAN Steering on HSI



Figure 43. TACAN Steering on HUD

DATA Option Sublevel

Upon selecting the DATA option button from the top of the HSI page, the DATA sublevel page is displayed with further sublevels for A/C (aircraft), WYPT (waypoint), and TCN (TACAN). The HSI pushbutton returns the MPCD/DDI to the main HSI page.

A/C (Aircraft) Sublevel

The following items are functional in this Early Access version:

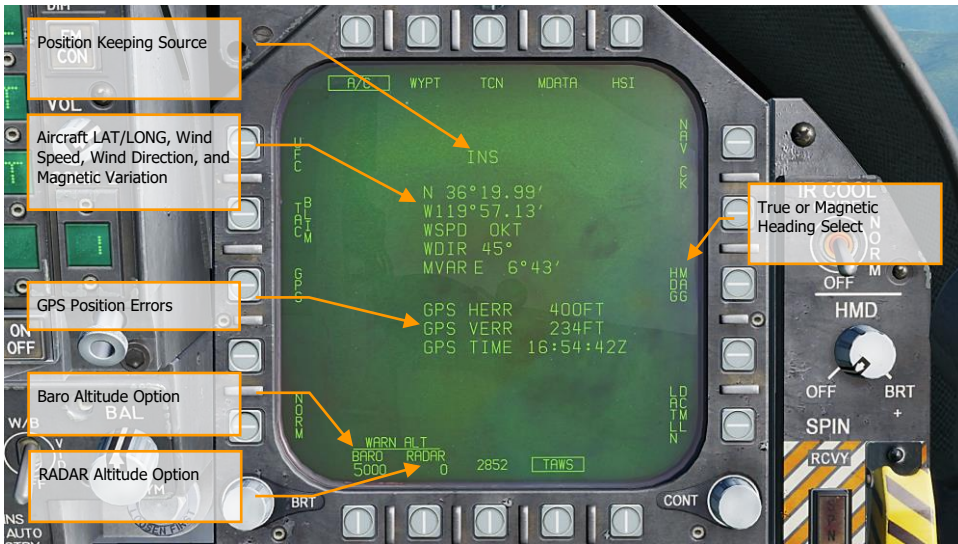

Figure 44. Aircraft HSI DATA Sublevel

Note: BARO (barometric) and RADAR altitude warnings are set by pressing their pushbuttons and then entering the desired altitude warning on the UFC for the ALT option select. Maximum value for RADAR is 5,000 and 25,000 for BARO. Flying below the set value will trigger the ALTITUDE, ALTITUDE alert.

WYPT (Waypoint) Sublevel

The following items are functional in this early access version:



Figure 45. Waypoint HSI DATA Sublevel

TCN (TACAN) Sublevel



Figure 46. TACAN HSI DATA Sublevel

Automatic Direction Finder (ADF) Navigation

A third method of navigation is Automatic Direction Finder (ADF). ADF uses radio-navigation based on beacons in the 190 to 535 kHz range. Either radio in the Hornet can be tuned to the desired ADF channel and receiving steering information for the selected beacon. However, no range information is given. The bearing to the selected ADF beacon is displayed as a circle on the outer periphery of the HSI compass rose.

How to Navigate Using ADF Beacons

1. Select either 1 (COMM 1) or 2 (COMM 2) from the ADF switch on the UFC
2. Rotate the channel selector of the selected ADF switch to the Manual (M)
3. Using the UFC keypad, enter the frequency of the desired ADF beacon into the UFC Scratchpad and press ENT on the UFC
4. The selected ADF beacon should now appear on the HSI as a circle and the ADF code will be heard (adjusted through the Volume Panel)

Additional HSI Symbolology

In addition to the HSI symbols described above, other symbols are present to assist in navigation. These include:

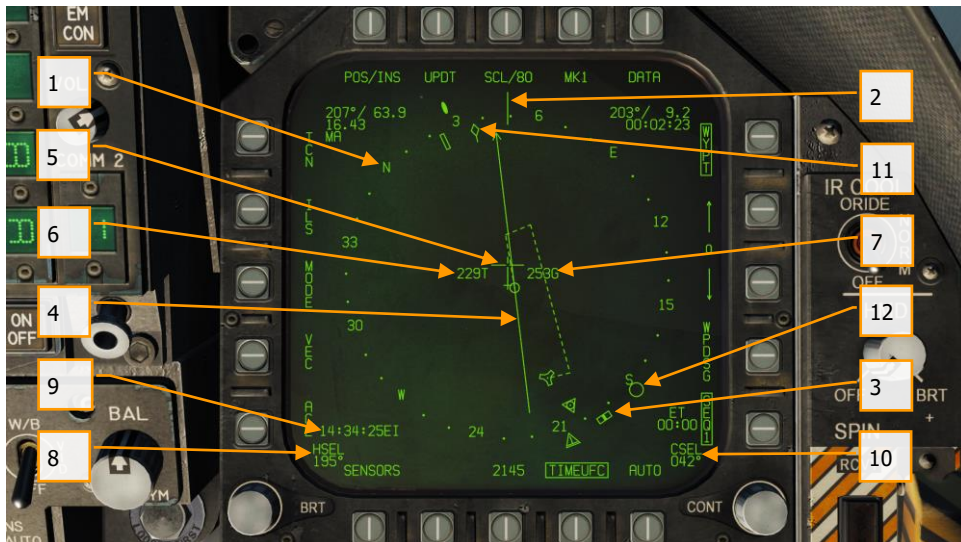

Figure 47. Additional HSI Symbols

1. **Compass Rose.** 360 degree compass with cardinal directions. Rotation of the compass is in reference to aircraft heading from a top-down view.
2. **Lubber Line.** A line marked on the compass rose that indicates aircraft heading.
3. **Heading Select Marker.** Heading marker on the compass rose to indicate set heading value as indicated in the Heading Select numeric indication.
4. **Course Line.** Set course line through the selected TACAN station or Waypoint and rotated to match the Selected Course numeric.
5. **Aircraft Symbol.** Placed in the center or de-centered in the compass rose, this indicates the location of the aircraft.
6. **Ownship True Airspeed.** True airspeed of your aircraft.
7. **Ownship Ground Speed.** True ground speed of your aircraft.
8. **Selected Heading.** Heading value set using the Heading Select Switch on the MPCD.
9. **Time.** Time indication as selected from the TIMEUFC option button.
10. **Selected Course.** Course value set using the Course Select Switch on the MPCD.
11. **Ground Track Pointer.** Actual track of the aircraft over ground.
12. **Automatic Direction Finding (ADF Symbol).** When ADF is selected to a valid frequency, this icon provides a heading cue to the selected ADF beacon. Not pictured.

Setting a Course

A course can be set using the Course Select Switch on the MPCD. The selected course value is then displayed on the HSI in the Course Select (CSEL) field and drawn through the selected TACAN or Waypoint. The Course Line has an arrow at the end that points in the direction of the set course. Pressing the Course Switch left and right allows the CSEL to be rotated to match the desired course.

On the HUD, the selected course is displayed as a small arrow with two dots on either side to denote course offset. The arrow provide a horizontal situation indication relative to the Velocity Vector. The dots left and right of the arrow indicate 4- and 8-degrees off course. The dots disappear when course error is less than 1.25 degrees.

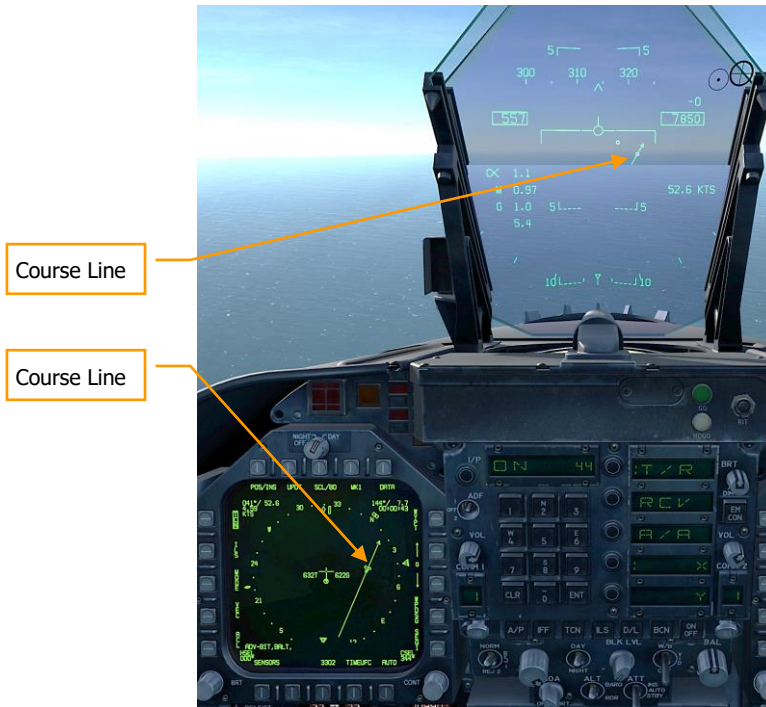

Figure 48. Course Setting on HSI and HUD

Autopilot Relief Modes

The Hornet includes several autopilots modes that assist the pilot in flying the aircraft. These are selected by pressing the A/P button on the lower portion of the UFC. Upon doing so, the available

autopilots modes are listed in the UFC Option Select Windows. For this Early Access version, the pilot assist autopilots modes include:



Figure 49. UFC Autopilot Modes

- **Attitude Hold (ATTN)**. The aircraft will maintain the existing pitch and roll attitude between +/- 45-degrees in pitch and +/- 70-degrees in roll.
- **Heading Select (HSEL)**. When enabled, the aircraft will turn to and fly the heading as set on the HSI.
- **Barometric Altitude Hold (BALT)**. When engaged, the aircraft will maintain the current heading and barometric altitude between 0 and 70,000 feet.
- **RADAR Altitude Hold (RALT)**. When engaged, the aircraft will maintain current heading and RADAR altitude between 0 and 5,000 feet.

Autopilot modes listed on the UFC are selected by pressing the Option Select Button next to the Option Select Window of the autopilot mode. When selected, a colon is displayed next to the autopilot name on the Option Select Window. Once selected, pressing the ON/OFF button on the UFC enables the mode. An A/P advisory is displayed on the left DDI when an autopilot mode is engaged.

Autopilot is disengaged by pressing the Paddle Switch on the Control Stick.

HORNET AIR-TO-GROUND (A/G)

For this Early Access release of our Hornet, we are including the M1A2 gun and unguided weapons for ground attack. In later updates, guided A/G weapons will be added. Additionally, A/G RADAR and FLIR will also be added later during the Early Access period.

Instant Action Mission Practice: Hornet CCIP Bombing

To place the Hornet in A/G mode, first press the A/G button from the Master Mode from the left instrument panel and there must be no weight on wheels. If the Master Arm switch is placed in the SAFE training position, weapon release is inhibited and the SIM training mode is available. When in the ARM position, weapons may be released normally.

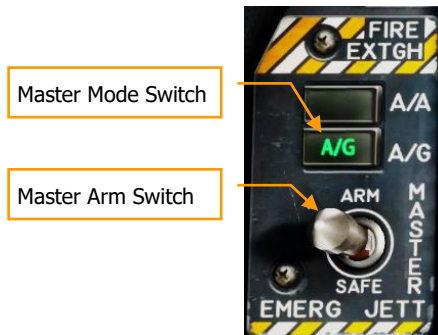

Figure 50. A/G Master Mode Select

Air-to-Ground Stores Management System (SMS) Bombing Page

Upon selection of the A/G master mode, the A/G SMS page is displayed on the left DDI. Based on the priority weapon, the information on the SMS page can vary. For conventional bombs, the SMS commonly includes the following:

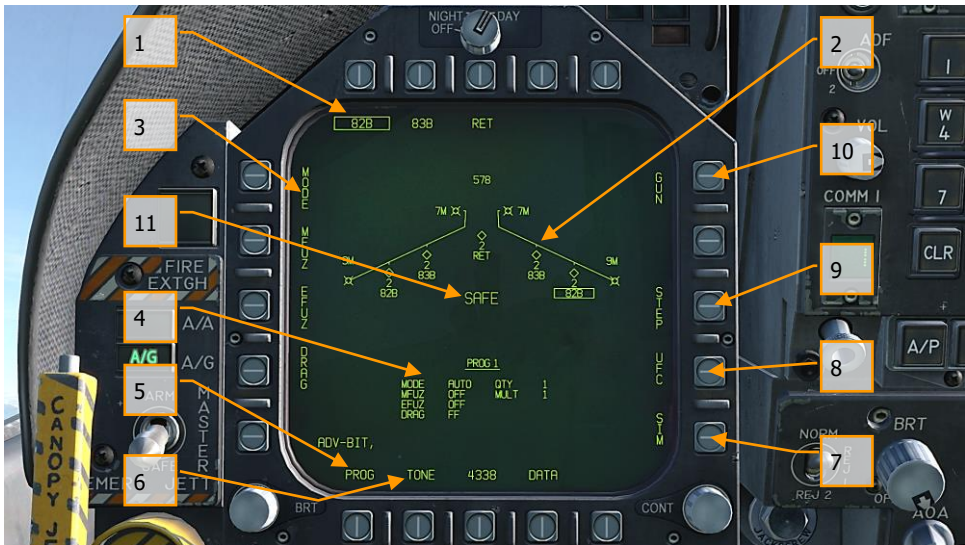

Figure 51. A/G Conventional Bombing SMS Page

- Weapon Select Options.** The top row of pushbuttons are used to select the desired A/G weapon. One option is provided for each displayed weapon type (maximum 5). An abbreviation of the selected weapon type is displayed below the pushbutton. When a weapon is selected, the abbreviation is boxed. Pressing the button again will unselect the weapon. If the A/G weapon is in a release condition, "RDY" is displayed below the weapon box. Otherwise, an "X" is displayed through the weapon box.
- Wingform Display.** The wingform display provides the number, type, and status of all stores loaded on the aircraft's weapon stations. A weapons rack is indicated as a diamond symbol, and the number below indicates the number of weapons loaded on the rack / station. Various indications can be displayed below the number of weapons numeric to indicate weapon status, such as: RDY (ready), STBY (standby), selected (SEL), LKD (locked) and ULK (unlocked). A box is displayed around the weapon abbreviation on the wingform when it is selected as the priority weapon. The gun rounds remaining is indicated at the top of the wingform (578 being a full load and XXX when empty).
- Delivery Program Options.** Based on the selected weapon, it may have different delivery options that can be adjusted using these pushbuttons along the left side of the display. Pressing a program button then displays the possible settings for that program option. This will be discussed ahead in the A/G Stores Programming section of this guide.
- Program Data.** This area of the display is provided to show release settings as set in the Delivery Program Options for conventional and laser-guided bombs. When a Program contains invalid data, the PROG and number will have an "X" through it.

5. **Program Select Option (PROG).** This option is only available for conventional and laser-guided bombs and allows the selection of five release programs for each weapon type. Successive presses of the PROG pushbutton cycles through the programs. The selected program is displayed at the top of the Program Data. Any changes to the program data for a program is saved and can be retrieved later when the program is re-selected.
6. **Tone Option.** Only when the DATA option is enabled, the TONE option is displayed. This option is used to enable, a ½ second tone that is transmitted either over the COMM 1 or COMM 2 radios when the pickle button is pressed. The first press of this pushbutton changes the label to "TONE 1" and is boxed, and a second press changes the label to "TONE 2". A third press disables the tone function and returns the label to an un-boxed TONE. The Master Arm switch must be set to ARM.
7. **SIM Mode Option.** When the Master Arm Switch is set to SAFE, the SIM option becomes available. SIM mode allows simulated SMS page and HUD operations, but all weapon release functions are inhibited. When in SIM mode, SIM replaces the ARM/SAFE indication on the A/G SMS page.
8. **Up-Front Control (UFC) Option.** This option is displayed when the selected weapon can have data entered for it using the UFC like weapon release quantity, interval, etc.
9. **Station Step Option (STEP).** The option is provided when the Stores page determines that the weapons of the selected type are available for release on more than one weapon station. Each successive press of the STEP push tile changes the selected weapon to the next weapon station.
10. **Gun Option.** The GUN option is used to select the gun as the priority A/G weapon, or enable the gun to be used in conjunction with delivery of another weapon (HOT GUN).
11. **Master Arm Status.** This displays the status of the Master Arm switch, and can be either ARM, SAFE or SIM.

A/G Stores Programming

Programming A/G stores can be done from either A/G or NAV master modes. Up to five delivery programs can be created for each A/G weapon except the gun. Using the PROG pushbutton, you can cycle through the programs with successive presses. There are two primary aspects of creating a delivery program for a weapon: The Delivery Program Options along the left side of the SMS page and the UFC.

Delivery Program Options

For the Hornet Early Access, the A/G weapons are primarily conventional, unguided bombs that use the same set of delivery program options. After selecting a Delivery Program Option, the left side of the SMS page will change the pushbuttons to show the possible selections for the selected option:

- MODE (Delivery Mode)
 - AUTO (Automatic)
 - FD (Flight Director) – non-function for this Early Access version
 - CCIP (Continuously Computed Impact Point)
 - MAN (Manual Release)
- MFUZ (Mechanical Fuze)
 - OFF

- NOSE (Nose Fuze Only)
- TAIL (Tail Fuze Only)
- NT (Nose and Tail)
- EFUZ (Electronic Fuze)
 - OFF
 - VT (Variable Time or Proximity)
 - INST (Instantaneous)
 - DLY1 (Delay 1)
 - DLY2 (Delay 2)
- DRAG
 - FF (Free Fall)
 - RET (Retarded)



Figure 52. UFC Bomb Settings

By pressing an Option Select Key on the UFC, you can select the bomb program parameter to enter. The selected parameter is indicated by the colon (:) next to the indicator of:

- **Quantity (QTY)**. Number of bombs to release, ranging from 1 to 30. When more than one bomb is selected, you must hold the Weapon Release Button down until all bombs in the salvo are released.
- **Multiples (MULT)**. Number of bombs to be released simultaneously from the weapon stations in each salvo

- **Interval (INT)**. The ground impact spacing in feet when in AUTO, FD, and CCIP modes, but milliseconds when on MAN mode.

After each value is entered using the UFC keypad, the ENTER button on the UFC must be pressed to save the value to the program. Once saved, the value is displayed on the Program Data for the selected program (1 to 5).

Another possible UFC option is the Reticle (RTCL) option. When displayed, you may enter a value in milliradians for manual delivery release. This in turn adjust the bombing reticle on the HUD. This will be discussed in the Manual Bombing section of this guide.

Air-to-Ground Bombing HUD

For the initial Early Access release of the Hornet, the HUD has three weapon delivery modes:

- Continuously Computed Impact Point (CCIP)
- Automatic (AUTO)
- Manual (MAN)

Continuously Computed Impact Point (CCIP) Bombing HUD

The CCIP mode is a computed visual delivery mode with manual weapon release. This mode allows a high degree of flexibility since the point on the ground at which the weapon will impact is continuously indicated by a CCIP Bombing Cross on the HUD. No target designation is required. In essence, place the thing on the thing and drop the bomb.

To use, fly to place the CCIP bombing cross over the intended target and hold the Weapon Release Button down (pickle button). A Displayed Impact Line (DIL) is also on the HUD between the CCIP bombing cross and the velocity vector. The pickle button must be held down until all bombs have been released as part of the program.

After bomb release, the Time To Impact (TTI) is presented on the HUD as the Time Of Fall (TOF).

If the CCIP impact point does not lay within the HUD field of view, the CCIP Reflected Cue is shown as a short, horizontal line on the DIL instead of the CCIP Bombing Cross. The cue is displaced to the same distance above the bottom of the DIL as the computed position of the CCIP Bombing Cross is below the HUD limit.

Instant Action Mission Practice: Hornet Conventional Bombing

How to Bomb Using CCIP Mode

1. Master Mode switch to A/G
2. Select a conventional A/G bomb from the SMS page
3. Set MODE option to CCIP
4. Assign TDC to the HUD (Sensor Control Switch forward)
5. Fly to place the CCIP Bombing Cross over the target while keeping the Velocity Vector above the Pullup Cue
6. Press and hold the Weapon Release button, bombs away!

Elements of the CCIP Bombing HUD include:

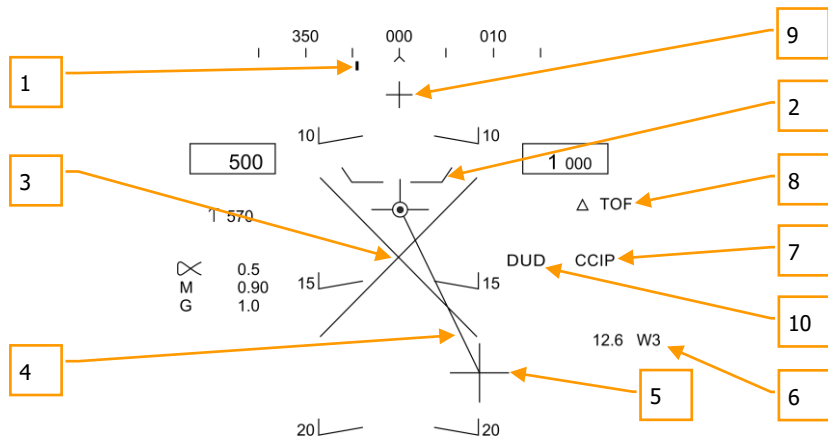

Figure 53. CCIP Bombing HUD

1. **Steering Point** (Command Heading). this pointer on the heading scale provides steering to the selected waypoint or TACAN station.
2. **Pullup Cue**. The distance between the Pull Up Cue and the Velocity Vector provides a relative indication of a safe altitude for delivering the selected weapon. For a safe weapon release, the Pull Up Cue should always be below the Velocity Vector. The Pull Up Cue also provides minimum altitude release for cluster munitions.
3. **Breakaway X**. The flashing Breakaway X will appear on the HUD when the Pull Up Cue is coincident or above the velocity vector.

4. **Displayed Impact Line (DIL).** The line between the CCIP Bomb Cross and the Velocity Vector represents the bomb fall line.
5. **CCIP Bomb Cross.** This cross represents the impact point of the bomb(s).
6. **Waypoint and Distance.** Selected waypoint number and distance to the selected waypoint in miles. If in TACAN steering, this would be in relation to the selected TACAN station.
7. **Mode Indication.** The selected bombing mode. CCIP in this situation.
8. **Time of Fall.** Estimated time until weapon impact of the last weapon released. This is indicated in seconds with a "TOF" suffix.
9. **Hot Gun Cue.** Displayed when GUN has been selected from the SMS page. The gun can be fired while in CCIP using the trigger.

CCIP Target Designation Option: When in CCIP mode and the TDC is assigned to the HUD, and the CCIP Bombing Cross is within the HUD field of view, pressing the TDC displays the TD on the HUD and it can be slewed within the HUD field of view using the TDC. The TD will initialize on the Velocity Vector or at 7.5 degrees, whichever pitch angle is greater. When the TDC button is released, AUTO bombing mode is entered based on the new target location.

Automatic (AUTO) Bombing HUD

The AUTO mode provides computed, automatic release of bombs. It computes release solutions for dive, dive toss, level, and low angle lofts up to 45 degrees. This mode requires a ground designation point from which to build the bombing solution. Command steering is provided to the appropriate weapon release point and the weapon will release automatically at the proper time such that the weapons hit the target.

Instant Action Mission Practice: Hornet Conventional Bombing

The Mission Computer (MC) provides an Azimuth Steering Line (ASL) to provide steering to the designated target. Designation is accomplished pressing and holding the Weapon Release Button when the Reticle or TDC are over the target. By placing the Velocity Vector on the ASL and holding down the Weapon Release Button, the weapon will release at the proper time and account for wind.

How to Bomb Using AUTO Mode

1. Master Mode switch to A/G
2. Select conventional A/G bomb from the SMS page
3. Set MODE option to AUTO
4. Assign TDC to the HUD (Sensor Control Switch forward)
5. Fly to place the Reticle over the target and then designate the target by pressing the TDC switch
6. While flying to keep the Velocity Vector above the Pullup Cue, keep the Velocity Vector over the Azimuth Steering Line (ASL), and hold the Weapon Release button down when the Release Cue appears on the HUD
7. Release the Weapon Release Button once all bombs in the pass have been released

Target Designation

In order to calculate a bombing solution in AUTO mode, a target first must be designated. For this initial Early Access Hornet, this can be done by:

- Designating a waypoint location as the target as set on the HSI using the WPDSG option.
- Flying to place the reticle pipper over the target and designate it with the Weapon Release Button
- Setting the TDC to the HUD and slewing the TDC over the target and designating it by pressing the TDC switch



Figure 54. AUTO Bombing HUD, No Designation



Figure 55. AUTO Bombing HUD, No Designation <7.5 Degree Dive Angle

1. **Reticle.** This Reticle consists of tic marks in 50-mil diameter circle with a pipper in the center. The TDC must be assigned to the HUD (Sensor Control Switch forward) for the reticle to be visible on the HUD. The Reticle serves as a steering reference for weapon delivery by having the pilot fly the aircraft to place the pipper of the Reticle over the intended target and then designating it.
2. **Pullup Cue.** The distance between the Pull Up Cue and the Velocity Vector provides a relative indication of a safe altitude for delivering the selected weapon. For a safe weapon release, the Pull Up Cue should always be below the Velocity Vector. The Pull Up Cue also provides minimum altitude release for cluster munitions. When the Velocity Vector is below the Pullup Cue, the Breakaway X is displayed on the HUD.
3. **Mode Indication.** Indication of the selected bombing mode from the Stores page.
4. **Waypoint and Distance.** The selected waypoint number and the distance to the waypoint in miles. If the target is co-located with the waypoint, this will also be the Target Distance. This may also be in reference to TACAN steering.
5. **Hot Gun Cue.** Displayed when GUN has been selected from the SMS page. The gun can be fired while in AUTO mode using the trigger.
6. **Displayed Impact Line (DIL).** The flashing, dashed DIL is displayed on the HUD when dive angle is greater than 7.5 degrees. The DIL extends from the Vertical Velocity indicator to the center of the Reticle.

Once the target is designated, the Azimuth Steering Line (ASL) is displayed on the HUD and provides steering direction to the target as indicated by the Steering Pointer on the Heading Scale. When within the HUD field of view, the target will also be marked with a diamond Target Designator that denotes the targets line of sight location. By flying the aircraft to keep the Velocity Vector on the ASL, the aircraft will assume the correct azimuth steering to satisfy the bombing solution. By flying to maintain the Velocity Vector over the Pullup Cue, adequate release altitude is also assured to avoid weapon fragmentation and weapon fuzing.

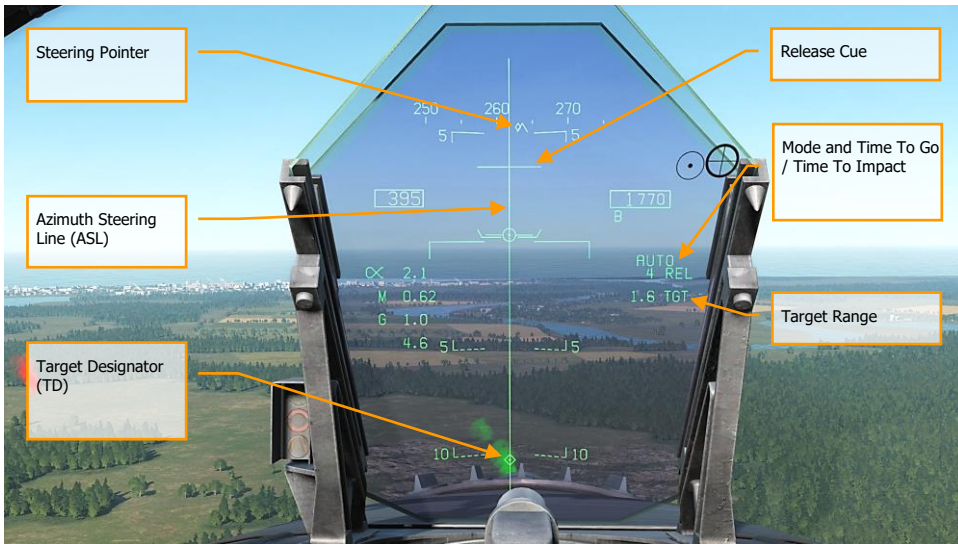

Figure 56. AUTO Bombing HUD, Designated

1. **Steering Pointer.** Once a target has been designated, the cue changes from a line indicating navigation steering (waypoint or TACAN), to a diamond that indicates steering to the designated target.
2. **Release Cue.** This small, horizontal line centered on the ASL is displayed when the target is designated, and it indicates both in-range and release cue anticipation indicator. For high drag bombs, the cue is displayed 5 seconds before release.
3. **Azimuth Steering Line (ASL).** The ASL is always perpendicular to the horizon and provides an azimuth steering reference to the designated target with respect to the Velocity Vector. The ASL is removed from the HUD when the target command steering is greater than 90 degrees
4. **Target Designator (TD).** This symbol shows the line of sight to the designated target. The symbol is 9 mils long on each side and has a pipper in the center when the TDC is assigned to the HUD. Using the TDC, the TD can be moved within the HUD field of view (useful when refining a target designation). If the TD is outside the HUD field of view, it is clamped to the nearest side and flashes. The TD is removed from the HUD when the target command steering is greater than 90 degrees.
5. **Time To Go / Time To Impact.** Upon target designation, the estimated time to release is indicated in seconds with an "REL" suffix. After the bomb(s) is released, this field indicates the estimated Time To Impact and is indicated in seconds of the last weapon released with a "TTI" suffix.
6. **Target Range.** When the target is designated, the range to the target is indicated in miles.

Note that when the target is not within the HUD field of view, the target arrow is displayed that points in the direction of the target and the number of degrees to the target is displayed next to the arrow.

Manual (MAN) Bombing HUD

Manual mode is a backup mode for visual delivery. From the A/G SMS page with MAN selected as the delivery mode, the UFC function allows the pilot to adjust the HUD reticle position in mils. By understanding the bombing table data for a weapon (release angle, altitude and airspeed), the manual mode can be an effective means to place bombs on target.

Instant Action Mission Practice: Hornet MAN (Manual) Bombing

How to Bomb Using MAN Mode

1. Master Mode switch to A/G
2. Select weapon
3. Select conventional A/G bomb from SMS page
4. Set MODE option to MAN
5. Select the UFC Option Select Button on the A/G SMS page and enter the desired mils setting on the UFC using the keypad. When complete, press the ENTER button on the UFC
6. Fly to place the Reticle over the target based bombing table data

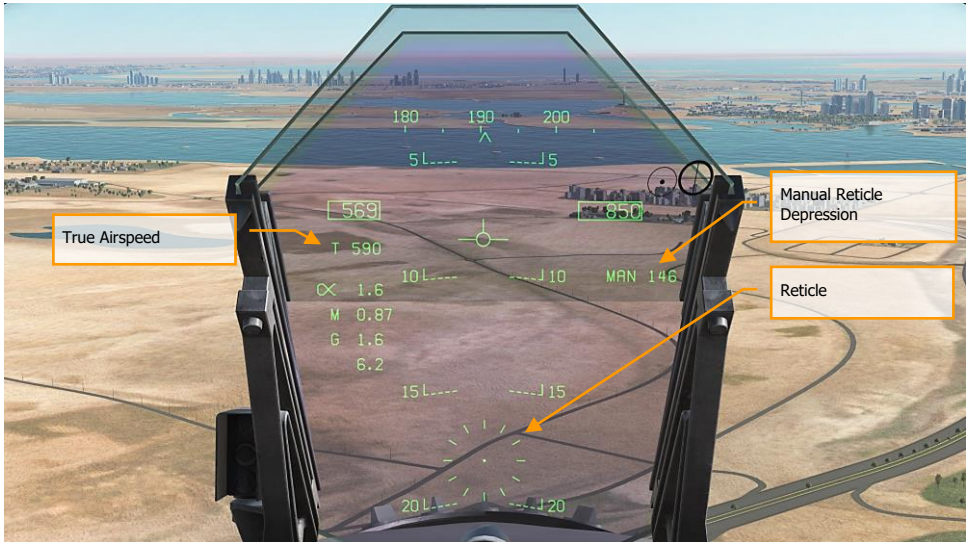

Figure 57. MAN (Manual) Bombing HUD

1. **Manual Reticle Depression.** Depression of the Reticle in mils based on the UFC input.
2. **Reticle.** Fixed Reticle at static position on the HUD based on the manual mils setting.
3. **True Airspeed.** When in MAN mode, True Air Speed (T) is displayed below the indicated airspeed box.

Air-to-Ground Gun and Rockets

Two modes for the A/G gun and rockets are available from the A/G Stores page: CCIP and MAN. These can be enabled by selecting the weapon from the A/G SMS page and then selecting the desired delivery mode. They feature either a "point and shoot" CCIP reticle or a manually adjusted manual sight based on a manual mils setting. Both the A/G Gun and Rockets are very similar in their programming, HUD, and delivery modes.

Instant Action Mission Practice: Hornet A/G Gun

Instant Action Mission Practice: Hornet Rockets

How to Use A/G Guns

1. Master Mode switch to A/G
2. Select/box GUN on the A/G SMS page with no other weapon selected
3. Select Mode as CCIP
4. Fly to place the pipper in the center of the Reticle over the target and hold down the trigger when the IN RNG or SHOOT cue appear on the HUD

How to Use Rockets

1. Master Mode switch to A/G
2. Select rockets at the top of the A/G SMS page
3. Select Mode as CCIP Mode
4. Fly to place the pipper in the center of the Reticle over the target and hold down the trigger when the IN RNG or SHOOT cue appear on the HUD

A/G Gun SMS Page



Figure 58. A/G Guns SMS Page

1. **A/G Gun Option.** The A/G gun is selected by pressing the GUN Option Select Button on the A/G SMS page. If another weapon is selected, the gun will operate in Hot Gun mode (fixed 2,000 ft gun cross). When selected, the GUN legend is boxed and an RDY (Ready) indication is displayed to the left of the box.
2. **Mode Selection.** Separate buttons are available for CCIP and MAN modes. Selecting a mode boxes the legend.
3. **Gun Ammunition Type.** Gun ammunition can be selected between M50 and PGU-28B 20mm rounds. The selected gun round type is boxed.
4. **Gun Fire Rate.** HI (High) and LO (Low) gun fire rates can be selected with the selection being boxed.
5. **UFC.** When the Mode is set to MAN (Manual), the UFC Option Select Button is displayed. Pressing this button boxes the legend and allows the pilot to manually enter the gun reticle depression on the UFC. The value can range from 0 to 270 mils. Once complete, the ENTER button on the UFC is pressed to save the value. Note that this value is not saved to a program.
6. **Reticle Setting.** Next to the RTCL is the entered reticle setting in mils.
7. **Gun Rounds Remaining.** At the top of the Wingform, the number of gun round remaining is displayed, with a full load being 578 rounds.

Rockets SMS Page



Figure 59. Rockets SMS Page

1. **Rocket Selection.** The top row of options is used to select the desired A/G weapon. One option is provided for each displayed weapon type (maximum 5). An abbreviation of the selected weapon type is displayed below the push tile. When a weapon is selected, the abbreviation is boxed. Pressing the button again will unselect the weapon. If the A/G weapon is in a release condition, "RDY" is displayed below the weapon box. Otherwise, an "X" is displayed through the weapon box.
2. **Wingform Indication.** When a rocket pod is selected, its indication on the Wingform will be boxed. Next to the rocket type abbreviation, the number of remaining rockets in the pod on the station is indicated. Successive presses of the STEP button will cycle the selected weapon station of rockets of the same type.
3. **Mode Selection.** Separate buttons are available for CCIP and MAN modes. Selecting a mode boxes the legend.
4. **Firing Mode.** Options for SGL (single) and SAL (salvo) are displayed when more than one rocket pod of the same type is loaded on the aircraft. When SGL is selected, one rocket will be launched with each press of the Weapon Release Button. When SAL is selected, two rockets will be launched with each press of the Weapon Release Button, from different rocket pods.

When SAL is selected, the weapon STEP option is not available.

5. **MTR (Motor) Type.** Most rockets can have one of two motor types: M4 or M66. Presses of the MTR Option Select Button cycles between the two types with the selected being boxed.
6. **UFC.** When the Mode is set to MAN (Manual), the UFC Option Select Button is displayed. Pressing this button boxes the legend and allows the pilot to manually enter the rocket reticle depression on the UFC. The value can range from 0 to 270 mils. Once complete, the ENTER button on the UFC is pressed to save the value.
7. **Reticle Setting.** Next to the RTCL is the entered reticle setting in mils.

A/G Gun and Rocket HUD



Figure 60. A/G Gun HUD

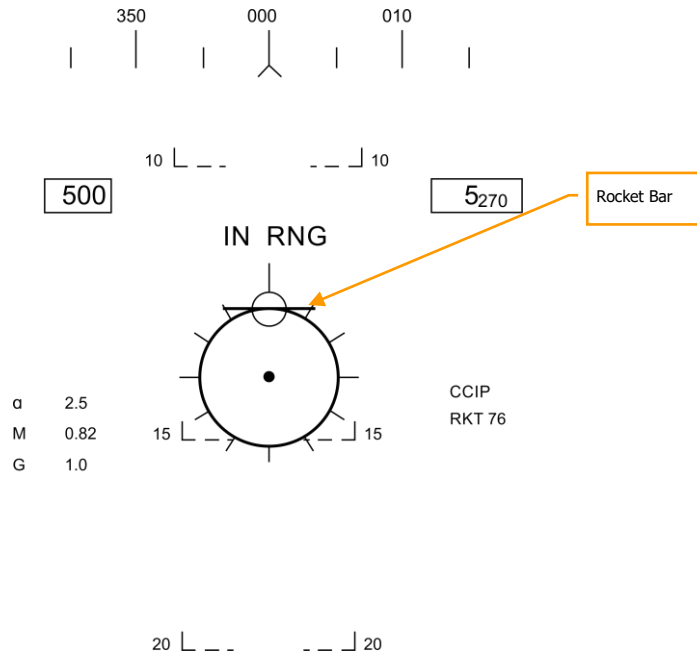

Figure 61. Rocket HUD

1. **Reticle.** This Reticle consists of tic marks in 50-mil diameter circle with a pipper in the center. When in CCIP mode, the Reticle indicates the calculated impact point of the gun rounds/rocket. When in MAN mode, the reticle is adjusted based on the depressible mils setting from the SMS page/UFC.

When in CCIP mode, an analog range bar is inscribed within the reticle. Slant range is provided by the RADAR via Air to Ground Ranging (AGR) and barometric altitude. Each tic mark on the reticle represents 1,000 feet of slant range and can indicate ranges from 0 to 23,000 feet. The bar will rotate clockwise to indicate increasing range and rotate counter-clockwise to indicate decreasing range.

2. **In Range / Shoot Cue.** When in CCIP mode and the gun/rocket is within maximum slant range of the pipper's aim point, the "IN RNG" cue is provided. If however there is a designated ground target, the "SHOOT" cue will be displayed if the gun/rocket is within range of the target.
3. **Mode.** The selected delivery mode for the gun/rocket is indicated as either CCIP or MAN based on the SMS page program setting.
4. **AGR Ranging Active.** When in CCIP mode and the RADAR is using AGR to determine range, the RDR indication is displayed.

5. **Weapon Type and Number Remaining.** The selected weapon name and the number of remaining rounds/rockets are displayed and updated as weapons are expended. This will display either GUN or RKT (rockets).
6. **Range to Target.** When a target has been designated and in CCIP mode is enabled, the range to the target is displayed in miles.
7. **Target Designator.** When the TDC is assigned to the HUD, the TD is displayed as a diamond within the HUD field of view with a pipper in the center. The TDC can then slew the TD within the HUD field of view.

When in MAN mode, true airspeed is displayed below the calibrated airspeed box.

Pressing the Cage/Uncage Button will fix the CCIP Reticle to 5,000 feet slant range.

HORNET AIR-TO-AIR (A/A)

Initial air-to-air weapons of the DCS: F/A-18C Hornet include the internal M61A2 20mm gun and the AIM-9L/M/P Sidewinder short-range missile.

For air-to-air weapon employment, you will need to be airborne with landing gear up and have the Master Arm switch set to ARM and A/A selected. When the Master Mode switch is in SAFE, the priority weapon indications on the HUD and RADAR will have an "X" through them. Also when in SAFE mode, the SIM training option is available.

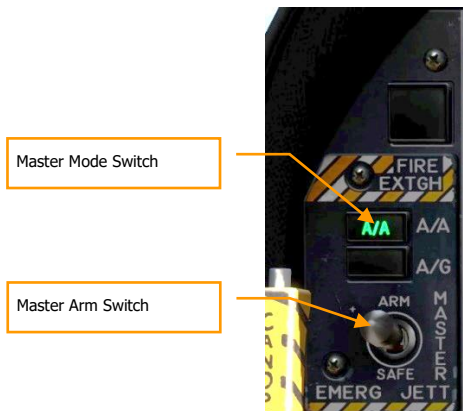

Figure 62. A/A Master Mode Select

Air-to-Air RADAR

Perhaps the most important sensor of the F/A-18C is its AN/APG-73 RADAR. The AN/APG-73 is an x-band, all-weather, coherent, multimode, multi-waveform search-and-track sensor that uses programmable digital processors to provide great flexibility in air-to-air tasks.

For this Early Access Guide, we will first discuss aspects of the RADAR that spans multiple modes, and then later we will discuss RADAR functions specific to unique applications/weapons.

Basic Air-to-Air RADAR Information

The AN/APG-73 is a pulse-Doppler, look-down / shoot-down RADAR with both Beyond Visual Range (BVR) and close in, Air Combat Maneuvering (ACM) modes of operation. For this Early Access version of our Hornet, we are including the Range While Search (RWS), Single Target Track (STT), and several ACM modes.

The air-to-air RADAR display uses a standard B-scope format in which the ownship (your aircraft) is located in the bottom center of the display. As such, all indications on the b-scope are ahead of the ownship. Targets on the scope are displayed in range from the closest being at the bottom and the more distant being toward the top. Contacts left and right of the ownship are represented as being indicted left and right of the center of the display to indicate azimuth.

Important, basic components of the b-scope include:

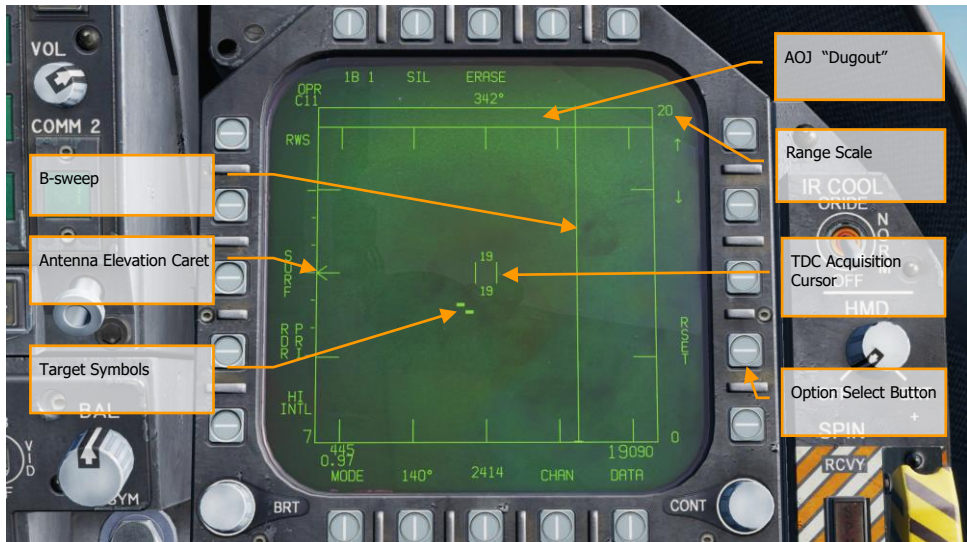

Figure 63. A/A RADAR Basic Symbols

1. **B-sweep.** The B-sweep is a vertical sweep on the display that indicates the instantaneous azimuth position of the RADAR antenna.

2. **Antenna Elevation Caret.** The antenna elevation caret symbol indicates antenna elevation in the vertical plane. The symbol is pitch and roll stabilized in reference to the ownship horizontal plane. In search modes, the symbol responds to the RADAR elevation control on the throttles.
3. **Range Scale.** The right side of the b-scope represents RADAR range. The scale includes marks for $\frac{1}{4}$, $\frac{1}{2}$, and $\frac{3}{4}$ of the selected RADAR range.
4. **TDC Acquisition Cursor.** Consisting of two parallel, vertical lines, this cursor is moved in response to Throttle Designation Control (TDC) commands on the throttles. When in a RADAR search mode, the altitude band being covered by the RADAR beam is indicated above and below the cursor. When placed over a target symbol, the contact's airspeed is indicated to the left of the cursor and its altitude is displayed to the right.
5. **Target Symbols.** Target symbols are displayed as solid rectangles (bricks). The horizontal position of the target symbol indicates angular position in respect to ownship heading. The vertical position indicates range.
6. **AOJ "Dugout".** Targets that are denying the RADAR range information are placed at the top of the b-scope in the Angle On Jam (AOJ) "dugout". Only target azimuth information is available.
7. **Pushbuttons.** Around the periphery of the RADAR display are 20 buttons that can be used to control RADAR modes and parameters. Depressing a button will enable or disable the function, or successive depressions will cycle through all available options for that function.

Range While Search (RWS)

Range While Search (RWS) is the default search mode for air-to-air or when an air-to-air missile is placed in priority. RWS mode provides all-aspect (nose-on, tail-on) and all altitude (look-up, look-down) target detection. The display shows range as the vertical axis and azimuth angle on the horizontal.

While in RWS mode, the RADAR can maintain up to 10 trackfiles.

Instant Action Mission Practice: Hornet A/A RADAR

How to Use RADAR in Beyond Visual Range Mode

1. RADAR control switch on the Sensor Panel to Operate (OPR)
2. Master Mode switch to A/A or NAV (A/A and A/G unselected)
3. Select Attack RADAR (ATTK RDR) from the TAC page on the right DDI
4. Use Throttle Designator Control (TDC) to move the TDC cursor on the RADAR display tactical area
5. Lock the target by either pressing down on the TDC or pressing the Sensor Control switch to the right, or...
6. Place TDC not over a target symbol and press Sensor Control switch right to lock closest target in RADAR scan volume

Information and functions of RWS mode consist of:

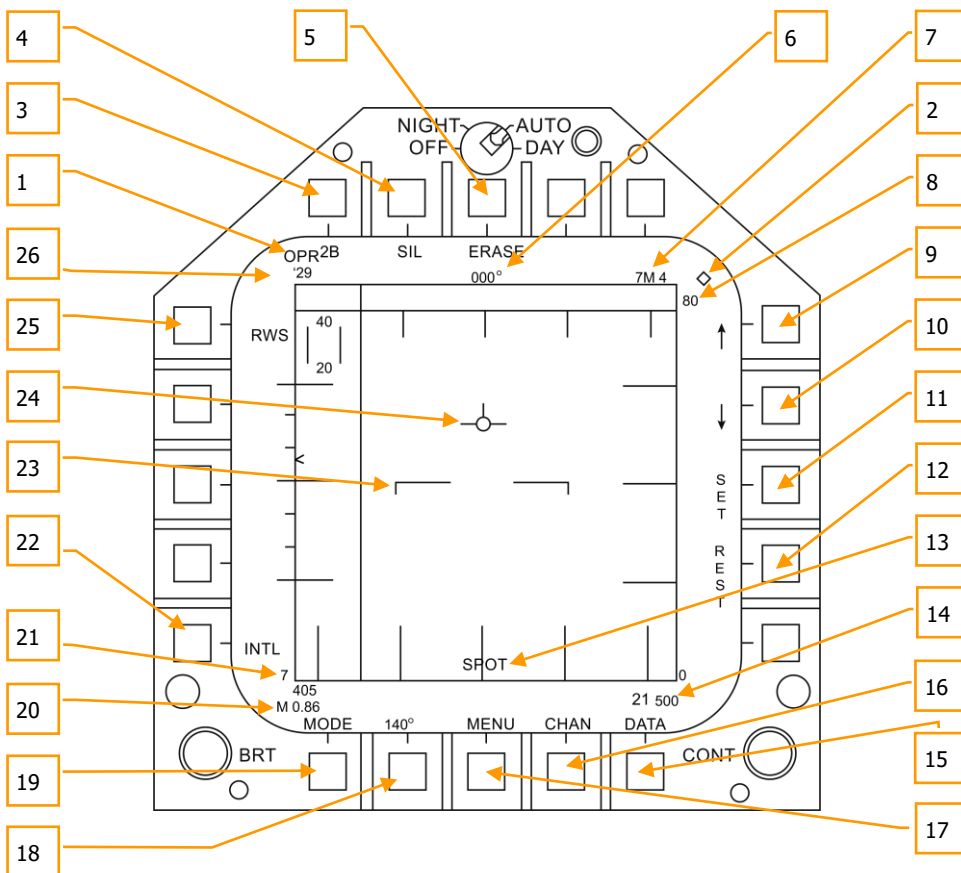

Figure 64. Range While Search (RWS)

Primary control of the air-to-air RADAR is done with the Throttle Designator Control (TDC). This can be used to position the TDC cursor and pressed to initiate an action.

1. **Operational Mode.** When the RADAR operating and emitting, this indicator shows OPR. When the RADAR is in standby mode, it displays as STBY.
2. **TDC Control Indication.** When the RADAR display is selected for TDC control, this diamond symbol is displayed in the top right corner of the display. Selecting the RADAR for TDC control is done by moving the Sensor Control Switch to the right. Note that the RADAR is normally placed on the right DDI.

3. **Elevation Bar Scan.** When in RWS, successive presses cycle between 1, 2, 4 and 6 bars of raster scanning. The greater the number of bars equates to a larger elevation volume being scanned. However, the greater the number of bars equates to a longer period of time to complete a complete scan (frame). Bar spacing is generally 1.3 degrees; however, when 5 nm scale is selected, it is 4.2 degrees.
4. **Silent (SIL) Mode.** When SIL mode is selected (boxed), the RADAR ceases scan operation and places the RADAR in standby mode. This is also indicated by the Iron Cross shown in the lower left portion of the display.

When in SIL mode, the ACTIVE option is available in the top left corner of the display (replaces target ageing indication). When pressed, the RADAR will conduct one complete scan / frame based on the current RADAR settings and properties. Once the scan is complete, it will automatically return to SIL mode.

5. **Erase.** By pressing the ERASE push button, all target history on the RADAR display are removed until detected and displayed again. This also removes all history during Silent (SIL) operation. This can be useful when a long age time is selected.
6. **Heading.** Ownship heading in degrees. This is generally the magnetic heading but true heading can be selected from the HSI/DATA/A/C sublevel.
7. **Weapon and Number.** The name of the priority weapon and the quantity of the weapon remaining.
8. **Display Range.** Selected display range of the RADAR. Possible settings are 5, 10, 20, 40, 80 and 160 nm.
9. **Range Increment.** Pressing this pushbutton increases the RADAR display range. When at maximum range, the increment arrow is no longer displayed. The arrow and function is removed if the RADAR is in STT mode.
10. **Range Decrement.** Pressing this pushbutton decreases the RADAR display range. When at minimum range, the increment arrow is no longer displayed. The arrow and function is removed if the RADAR is in STT mode.
11. **SET.** Pressing the SET pushbutton will save the RADAR settings for the weapon in priority. This includes display range, elevation bar scan, azimuth, PRF, and target ageing.
12. **RESET.** When pressed, the RADAR settings are returned to the default settings of the weapon in priority.
13. **Spot Light mode.** When the TDC designation switch is pressed and held for greater than one second, the RADAR will conduct a 22-degree in azimuth bar scan of the location of the TDC location using the current PRF and bar settings. During this, the SPOT indication is displayed in the bottom center of the display. While in Spot Light mode, the TDC can be slewed 60 degrees. To cease Spot Light mode, the undesignated button is pressed.
14. **Altitude.** Ownship altitude.
15. **DATA.** Press this pushbutton to change the RADAR display to the DATA sublevel.
16. **CHAN.** Select the radio frequency channel on which the RADAR will transmit. When selected, the CHAN indicator is replaced with AUTO MAN and the DCLTR option is replaced with the corresponding channel. Successive presses of the AUTO MAN button cycles between automatic and manual channel selection.

17. **MENU.** Press to return to the TAC page.
18. **Azimuth Scan.** The RADAR can have azimuth scan settings of 20, 40, 60, 80, and 140 degrees. Pressing this pushbutton cycles between the settings with successive presses.
19. **MODE.** Successive presses commands the RADAR to RWS, VS, or TWS modes. (not functional for this Early Access)
20. **Airspeed.** Ownship airspeed in IAS and Mach.
21. **Sensitivity Indicator.** Indication of RADAR level of gain when detecting contacts. High numbers indicate high sensitivity and low numbers indicate low sensitivity.
22. **PRF.** Pulse Repetition Frequency (PRF) selection between Medium (MED), High (HI), and INTL (Interleaved). Medium PRF minimizes "blind zones" reduces false targets, better all-aspect detection, but has less detection range. High PRF has greater range, but has inferior low to medium aspect detection. Interleaved alternates Medium and High bar coverage.
23. **Horizon Line.** Mirror of the HUD horizon line.
24. **Velocity Vector.** Mirror of the HUD velocity vector and is displayed at a fixed position and used in conjunction with the moving horizon line to indicate ownship flight path pitch and roll
25. **RADAR Mode.** Indication of the selected RADAR mode.
26. **RF Channel.** The RADAR's radio frequency channel as selected from the CHAN pushbutton.

Air-to-Air RADAR HOTAS Controls

When flying air combat missions, it is very helpful to keep your hands on the stick and throttle and not have to take your hands off them to manipulate controls. The Hornet has an excellent set of Hands On Throttle and Stick (HOTAS) controls. Here are some of the more important HOTAS functions to know for air-to-air combat:

Control Stick

On the control stick, the Sensor Control Switch and the Undesignated Button are vital. When in Beyond Visual Range (BVR) mode, pressing the Sensor Control Switch to the right will set TDC control to the RADAR when on the right DDI. When the display has the TDC assigned to it, a diamond with a dot in the center is displayed in the top right corner of the display.

Pressing the Sensor Control Switch to the right when the TDC is already assigned to it will place the RADAR in Auto Acquisition (AACQ) mode. If the TDC is over a target symbol when AACQ is commanded, it will instruct the RADAR to lock on to that target. If AACQ is pressed with no target symbol under the acquisition symbol, then the RADAR will attempt to lock on to the closest target within the selected RADAR scan volume.

Sensor Control Switch. There are two general modes for this four-way switch. When in air-to-air mode:

When in Beyond Visual Range (BVR) mode, it functions as:

- Forward: Switch to Air Combat Maneuvering (ACM) mode with Boresight being selected by default
- Aft: Assigned TDC to center, MPCD

- Left: Assigns TDC to left DDI
- Right: TDC to right DDI or enters RADAR in Auto Acquisition mode if TDC already assigned to the right DDI

When in ACM mode, the Sensor Control Switch works as:

- Forward: RADAR Boresight (BST) mode
- Aft: RADAR Vertical Acquisition (VACQ) mode
- Left: RADAR Wide Angle Acquisition (WACQ) mode
- Right: Exit ACM mode to Return To Search (RTS)

Weapon Select Switch. This is a five-position switch that allows you quickly to set the selected air-to-air weapon as priority. In doing so, it will also set the RADAR to default settings to best employ the weapon:

- Forward: AIM-7 Sparrow (no function for this Early Access version)
- Press Down: AIM-9 Sidewinder
- Aft: M61A2 20mm Gun
- Right: AIM-120 AMRAAM (no function for this Early Access version)
- Left: No Function

Trigger. Fires forward directed weapons like the gun and air-to-air missiles.

Undesignated Button. When in air-to-air mode, the primary function of the Undesignate Button is to un-lock a RADAR-designated targets. It can also be used to return to RADAR search mode when in a RADAR ACM mode.

Throttle

For this Early Access release, the two most important RADAR controls are the Throttle Designator Controller (TDC) and the RADAR elevation control.

The RADAR elevation control is a wheel that when rotated back elevates the RADAR scan and when rotated forward lowers the elevation scan.

The TDC is a cursor control with a press-button function. When assigned to the RADAR on the right DDI, it controls the TDC acquisition cursor within the RADAR tactical display area. When on the air-to-air RADAR display, the number above and below the TDC cursor indicate the maximum and minimum altitude coverage of the RADAR at the range of the TDC on the display.

When the TDC is moved across the display boundary, it can be used for RADAR mode and parameter changes. If the TDC is moved over the boundary into the mode selection area, the mode options will appear on the display. Positioning the cursor over the desired mode and depressing the TDC will command the RADAR to display the optimum parameters for the mode selected. Other parameters shown around the perimeter of the display may also be controlled.

Figure 65. HOTAS TDC Control Zones

Range While Search (RWS) DATA

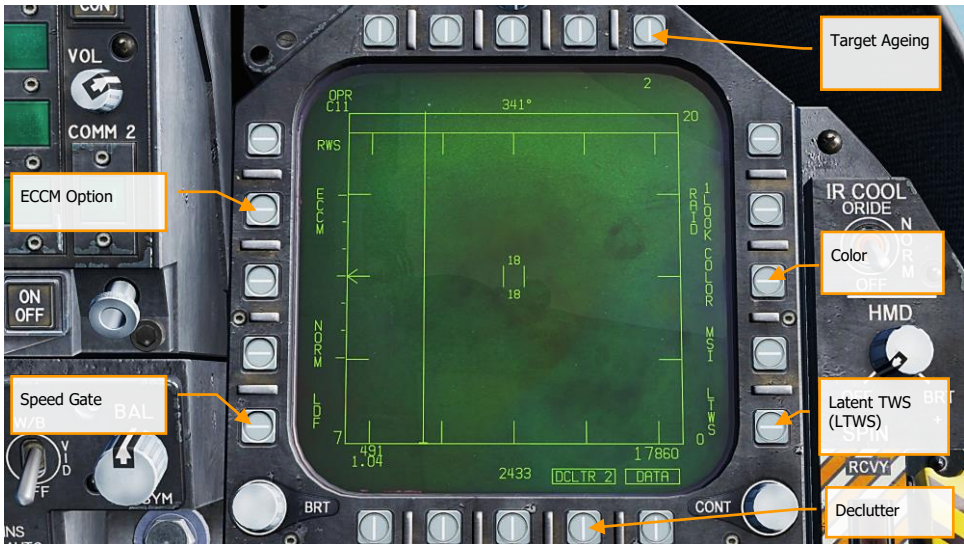

Figure 66. RWS DATA Sublevel

1. **Target Ageing.** The amount of time a target symbol remains on the display after RADAR contact has been lost can be adjusted with successive presses between 2, 4, 8, 16 and 32 seconds.

When SIL mode is selected, this field is replaced with the ACTIVE indication.

2. **COLOR.** Selects the RADAR display to be presented in monochrome or limited use of colors of three colors.
3. **Latent TWS (LTWS).** LTWS provides a Track While Scan (TWS) function while in RWS mode. With LTWS enabled, placing the TDC over a target symbol will display Launch and Steer (L&S) track symbols. However, no "Shoot" cues are displayed. An LTWS target will have its airspeed in Mach displayed to the left and its altitude in thousands of feet to the right. Additionally, its range and closure information is displayed along the right tactical border.
4. **DATA.** Exits the DATA sublevel
5. **Declutter.** Allows selection of two levels of declutter from the RADAR display. DCLTR1 removes the horizon line and velocity vector. DCLTR2 removes all DCLTR1 items, plus target differential altitude, target heading, range rate numeric, and the range caret when in STT mode. The selected mode will be indicated as boxed DCLTR1 OR DCLTR2.

6. **Speed Gate.** Selects between Normal (NORM) and WIDE target speed gates to determine the width of the doppler radial velocity notch. This is used to not detect/filter out slow moving targets like cars and general aviation aircraft. When in WIDE mode, the notch filter is increased and slow targets will be detected and displayed.
7. **ECCM.** Enables or disables Electronic Counter-Counter Measures. When enabled, the jamming effects of hostile aircraft are less pronounced, but the sensitivity of the RADAR is reduced.

Air Combat Maneuvering (ACM) Modes

The ACM RADAR modes are designed for close-in combat with auto acquisition in mind. The ACM modes can be selected by either pressing forward on the Sensor Control Switch while in air-to-air BVR mode, or by pressing aft on the Weapon Select Switch to set A/A GUN as priority.

Except for the Guns Acquisition mode, any air-to-air missile can be used for all ACM modes.

How to Use RADAR in Air Combat Maneuvering (ACM) Mode

1. RADAR control switch on the Sensor Panel to Operate (OPR)
2. Master Mode switch to A/A
3. Select Attack RADAR (ATTK RDR) from the TAC page on the right DDI
4. Press forward on the Sensor Control Switch to enter ACM mode, or...
5. Press aft on the Weapon Select Switch to set A/A Gun as priority and place the RADAR in Gun Auto Acquisition (GACQ) mode
6. Once in ACM mode, use the Sensor Control Switch to select ACM modes: forward for Boresight (BST), aft for Vertical (VACQ), and left for Wide Angle (WACQ)

There are four ACM modes:

- **Gun Acquisition (GACQ)** mode is automatically enabled when air to air guns is selected. This mode is represented as a 20 degree, dashed circle on the HUD that encompasses the entire HUD field of view. Unlike the other ACM modes, GACQ can only be used for guns. GACQ searches for targets out to 5 miles.
- **Boresight (BST)** by pressing forward on the Sensor Control Switch. When selected, a dashed, 3.3 degree circle is displayed on the HUD. This circle indicates the RADAR's auto-acquisition search zone. BST searches for targets out to 10 miles.
- **Vertical Acquisition (VACQ)** mode is selected by pressing aft on the Sensor Control Switch. Upon doing so, two, dashed vertical line are displayed in the HUD. This vertical auto-acquisition search pattern covers from -13 degrees to +46 degrees. VACQ searches for targets out to 5 miles.
- **Wide Acquisition (WACQ)** is a spaced-stabilized mode and is selected by pressing left on the Sensor Control Switch. Upon doing so, a rectangle is displayed in the lower right corner of the HUD. This rectangle represents the auto acquisition scan pattern and can be slewed using the TDC controller when uncaged. The rectangle is placed on a grid that

represents the complete scan limits of the RADAR. WACQ searches for targets out to 10 miles.

At Early Access release, WACQ will include caged mode, but uncaged mode will come later into the Early Access process.

- Automatic Acquisition Mode (AACQ)** is selected from the BVR RADAR modes, like RWS. It is not selected from the ACM modes. When in a BVR RADAR mode and the TDC cursor is not over a target symbol, the RADAR will attempt to auto lock the nearest target in its search pattern when the Sensor Control switch is moved right. AACQ searches for targets out to range setting of the RADAR. If the RADAR is already in ACM mode, selecting AACQ will exit ACM mode and return to last BVR mode.

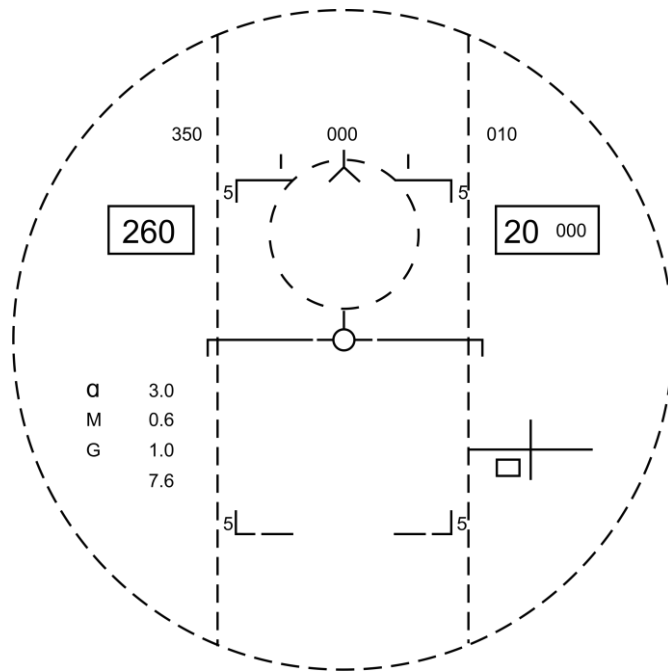

Figure 67. ACM RADAR Acquisition Zones

M61A2 Gun, Air-to-Air Mode (A/A GUNS)

The A/A-49A1 M61A1/M61A2 20MM automatic gun system provides the pilot with a formidable A/A weapon capability. The system has a capacity of 578 rounds of ammunition. The rate select switch provides for the selection of either 4,000 or 6,000 shots per minute.

The gun is used for close-in engagements and can either be RADAR-directed or not.

A/A GUNS is selected by an aft press on the Weapon Select Switch or **[LShift + X]**. To fire the gun, press the Trigger on the Control Stick **[Space Bar]**.

Instant Action Mission Practice: AA Gun and AIM-9 Sidewinder

How to Use the Gun Summary

1. Master Arm switch to ARM
2. Weapon Select switch to A/A GUNS
3. Fly to place target in dashed circle on the Heads Up Display (HUD) to lock it on RADAR when at 5 nautical miles or closer
4. Fly to place the dot in the center of the gun reticle over the target and squeeze the trigger when you see the SHOOT cue on the HUD.

A/A GUNS SMS Page

Regardless of which air-to-air gun mode you select, the air-to-air gun (A/A GUNS) SMS page will remain the same. The SMS page is accessed through the TAC menu DDI page, or it can be automatically called up by selecting A/A GUNS.

The A/A GUNS SMS page allows you to configure the following weapon settings:



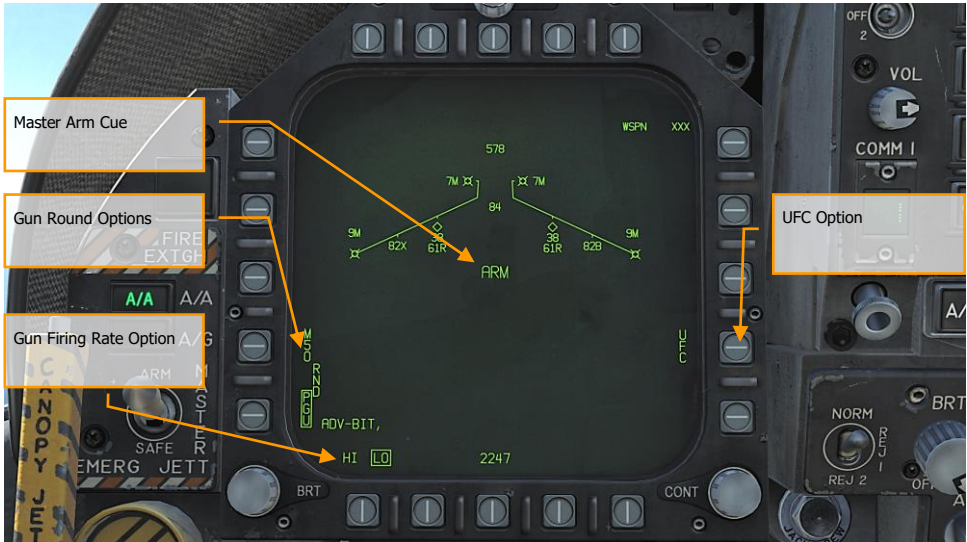

Figure 68. A/A GUNS SMS Page

1. **Gun rounds Remaining.** Displayed when available. If no rounds remain, XXX is displayed. A full gun load is 578 rounds.
2. **Gun Round Options.** RND M50/PGU option is provided to select the type of 20MM ammunition which is loaded. The selected ammunition type is boxed. The M50 option represents MK-50 series ammunition and the PGU option represents PGU-28 ammunition.
3. **Gun Firing Rate Option.** High rate (HI) is initialized on power up, pressing the Option Select Button selects the alternate gun fire rate (LO). Gun fire rate legend is boxed when selected. HI = 6,000 rounds per minute, and LO = 4,000 round per minute.
4. **Master Arm Cue.** The status of the Master Arm switch (ARM, SAFE) or the selection of simulation mode (SIM) is displayed.
5. **Expected Target Wingspan.** The UFC is used to program the wingspan size for the expected target. This selection is then used to properly adjust the Funnel Cue. The selectable wingspan values are whole numbers between 10 to 150 with a default of 40 feet. The wingspan value is entered by selecting the UFC Option Select Button 14 on the A/A GUNS SMS page. The current wingspan value is displayed as WSPN XXX. With WSPN displayed, the pilot enters a wingspan value using the keypad, followed by the ENT key.
6. **UFC Option.** Press to enable manual wingspan entry using the UFC.

A/A GUNS HUD

The Hornet has three functional A/A GUN modes:

- Radar Not Tracking Mode
- Training Mode (not for early access launch)
- Radar Tracking Mode

Radar Not Tracking Mode

The Radar Not Tracking Mode, also called the Funnel Mode, is obtained immediately upon A/A GUNS selection if the RADAR is not already tracking a target or at any time if RADAR track is lost or broken. To use the funnel, fly to place the target aircraft's wings between the funnel such that its wing tips just touch the sides of the funnel.

A fixed range of 2,000 feet is used for the radar not tracking mode lead angle computations. A 12.5-mil diameter stadia metric reticle, corresponding to a target wing span of 25 feet at this range, is displayed on the HUD.

Specific symbology to the Radar Not Tracking gun HUD includes:

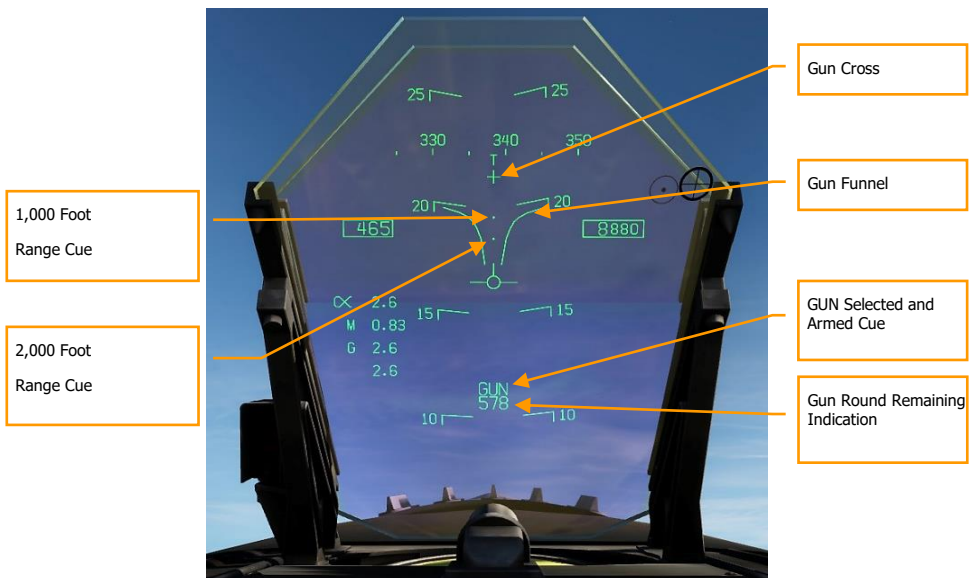

Figure 69. A/A GUNS HUD, Radar Not Tracking Mode

1. **Gun Cross.** Displayed when A/A gun is selected. The Gun Cross is centered in azimuth and 2° above aircraft waterline to indicate gun boresight.
2. **Funnel Cue.** The funnel mode is displayed if the RADAR is not tracking the L&S target, or if lock-on is broken.
3. **1,000 Foot Range Cue.** A range of 1,000 feet is represented by the piper.
4. **2,000 Foot Range Cue.** A range of 2,000 feet is represented by this pipper.
5. **GUN Selected and Armed Cue.** Indication of the gun being the selected weapon.
6. **Gun Round Remaining Indication.** Number of gun round remaining.

When A/A GUNS is selected and the RADAR is operating, the RADAR will automatically enter the air-to-air Guns Auto Acquisition mode (GACQ). This is a 5 bar elevation scan with 20 degrees of elevation centered 4 degrees below the RADAR boresight. This scan covers the entire HUD field of view. This mode also places the RADAR in a 5 mile range setting. When any aerial target flies within this scan zone, it will automatically be locked on to in Single Target Track (STT).



Figure 70. A/A GUNS Auto Acquisition Area

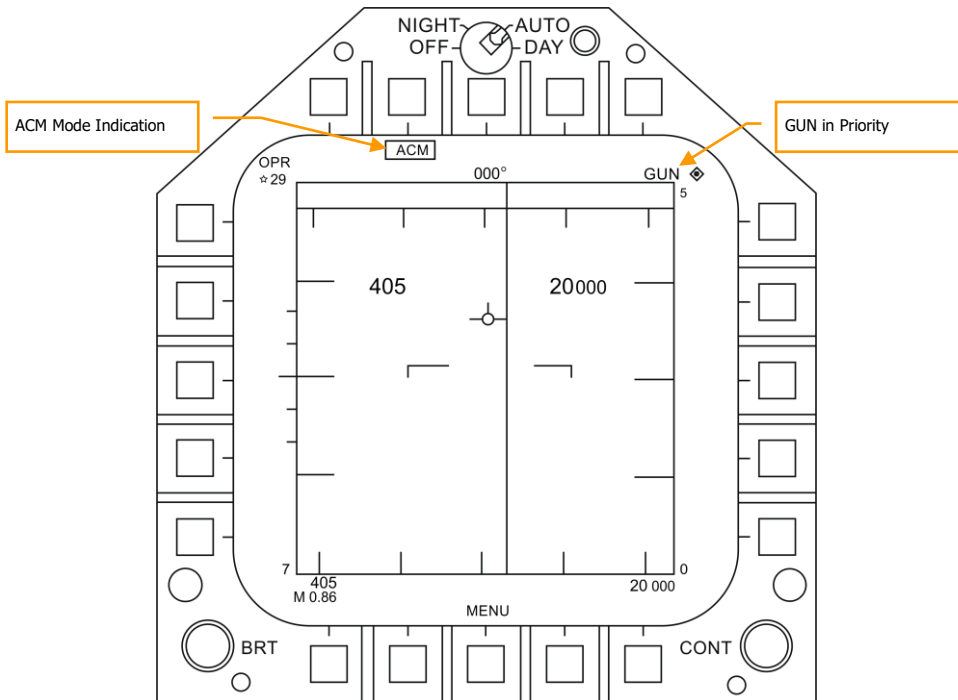

Figure 71. A/A GUNS Acquisition Radar

At any time, you can also select one of the ACM RADAR submodes. ACM submodes are selected by pressing the Sensor Control Switch forward. Once in ACM mode, the Sensor Control Switch can select three ACM submodes.

- Boresight (BST) Sensor Select switch forward
- Vertical Acquisition (VACQ) Sensor Select switch aft
- Wide Acquisition (WACQ) Sensor Select switch left

Note 1: When the RADAR is at a 5 nm range setting, ownship airspeed and altitude are displayed inside the RADAR display.

Note 2: When in a turning fight, VACQ can often be a good choice to lock up a target above your lift vector.

To return to GACQ, select GUNS on the Weapon Select Switch.

Radar Tracking Mode

Radar Tracking Mode is the primary air-to-air gun mode of the Hornet. Radar Tracking Mode is obtained immediately upon gun selection if the RADAR is tracking an aerial target. Valid range, range rate, and angle tracks are required for Radar Tracking Mode operation.

Once the RADAR is locked on, the Target Designator (TD) indicates the position of the target being tracked, and target range is displayed on an analog bar on the 50-mil diameter gun reticle along with a maximum firing range cue. Maximum gun firing range corresponds to a maximum bullet time of flight of 1.5 seconds and a minimum impact velocity (bullet V_c) of 500 feet per second or a minimum bullet velocity (V_b) at impact of 1,000 feet per second, whichever range is less. Maximum firing range is much greater head-on than tail-on.

An advantage of the Radar Tracking Mode is the use of RADAR track data. The use of track data makes the lead angle computation dependent only on target motion and the encounter geometry. The computed lead angle is essentially independent of aircraft attitude. The Radar Tracking Mode obtains firing solutions quickly since rapid attitude changes have little short term effect on the required lead angle. As a result, the pilot's task is solely flying to aim the gun reticle since the target tracking function is being performed by the RADAR.

As a further aid to the pilot and for consistency with the missile modes, a SHOOT cue appears if the target is within maximum firing range. If the predicted miss distance is less than 20 feet, and all other firing constraints (master arm, weight off wheels) are satisfied, the SHOOT CUE comes on. The SHOOT cue includes a 0.5 second anticipation needed for pilot reaction time plus gun delay time. The SHOOT cue remains on until the predicted miss distance exceeds 30 feet.

Radar Tracking Mode is automatically selected if A/A GUNS is selected while there is a RADAR lock. If there is no RADAR lock, it will go to Radar Not Tracking Mode.

Elements of the A/A GUNS Radar Tracking Mode on the HUD include:

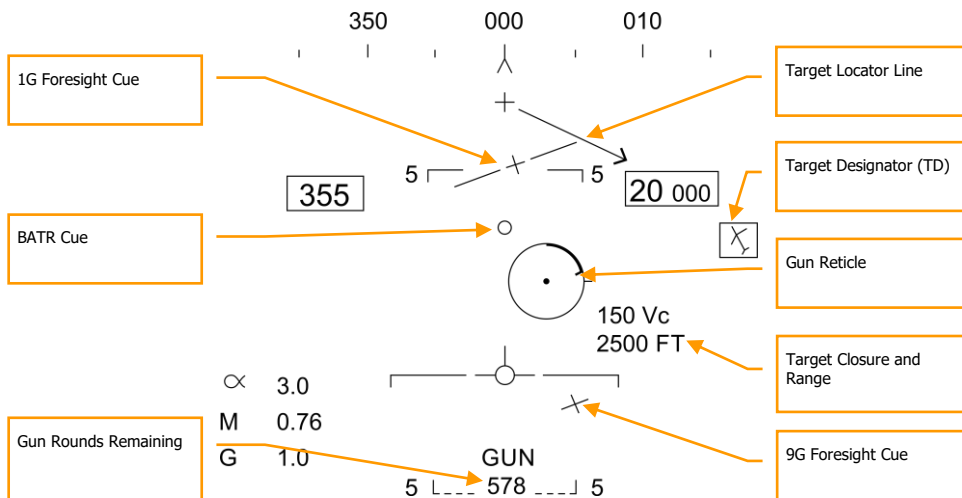

Figure 72. A/A GUNS HUD, Radar Tracking Mode

1. **Gun Reticle.** This circle indicates predicted gun impact location based on aircraft maneuvering. RADAR lock provides target range data that is included in the reticle. A maximum gun firing range cue is displayed on the gun reticle display. It indicates the maximum effective gun firing range. The target analog range bar inscribed in the gun reticle shows the current target range as indicated by RADAR is presented as a circular arc about the gun reticle, the length of which represents the target range increasing clockwise about the reticle. When the arc's clockwise length is less than the position of the Gun Maximum Range Cue, the target is within the range of the gun.
2. **1G and 9G FORESIGHT Cues.** Fluid Omni-Range/Rate Sight (FORSIGHT). The FORSIGHT cues indicates the targets potential to maneuver. It is made up of two horizontal lines with center tick marks. The upper or longer line represents the targets 1G left or right out-of-plane maneuver capability under 1G in-plane loading. The lower or shorter line represents the targets 9G left or right out-of-plane maneuver capability under 9G in-plane loading. The distance between the two FORSIGHT cue lines represents the 1G to 9G in-plane maneuver potential for the target. The separation between the 1G and 9G maneuver potential lines is not limited beyond Rmax (Gun Maximum Range cue). The 1G maneuver potential line is limited to the HUD field of view at the same distance from the HUD center used for the gun reticle. When the 1G maneuver potential line is HUD limited, it is displayed flashing.
3. **BATR Cue.** Bullet At Target Range (BATR). The BATR cue displays the real time position of a bullet at target range. The BATR cue serves as a post-fire or hypothetical bullet hit position cue. The cue is updated for each bullet fired as the bullet reaches the applicable target range. The cue is displayed on the HUD when the gun is firing or in SIM mode with the trigger held. The cue is displayed using the gun boreline offset from the target LOS.

4. **Gun Cross.** The Gun Cross is centered in azimuth and 2° above aircraft waterline to indicate gun boresight.
5. **Target Locator Line.** Attached to gun cross, this arrow will point in direction of TD box when TD box is off the HUD field of view. The number of degrees to the target is also displayed next to the arrow.
6. **Target Designator (TD).** This is an indication of target location. If the target is identified as hostile, the box is rotated 45-degrees to create a diamond symbol and an inverted "V" symbol is placed over the diamond.
7. **Target Vc and Range.** When a valid RADAR STT track is established on the target, the target range and closing rate are displayed in nautical miles (NM) and feet/second. These are displayed in the same location as displayed when a missile is the selected weapon. When the target comes within 1NM, the range display reverts to a display of target range in 100's of feet.
8. **Gun Rounds Remaining.** Gun rounds remaining is displayed next to the GUN legend. XXX is displayed when the MC receives the last rounds signal from the SMS.

SHOOT Cue (not pictured). The shoot cue is displayed until target miss distance exceeds 30 feet. The shoot cue is provided when the below criteria have been satisfied:

- A/A Gun is selected
- All firing constraints are satisfied
- RADAR is in STT on the target
- Target is inside gun Rmax for the selected round type (MK-50 or PGU-28)
- Target center is within 20 feet of an imaginary line connecting the 1G and 9G pipper of the Foresight cue (maximum 20 feet miss distance)

When the RADAR is locked on to the target while in A/A GUNS in Single Target Track (STT) mode, the RADAR picture will appear as shown below. Note that the GACQ is indicated on the left side as the selected RADAR mode and that your airspeed and altitude are displayed inside the B-scope.

While in STT mode, the RADAR will automatically change scale based on the range to the locked target.

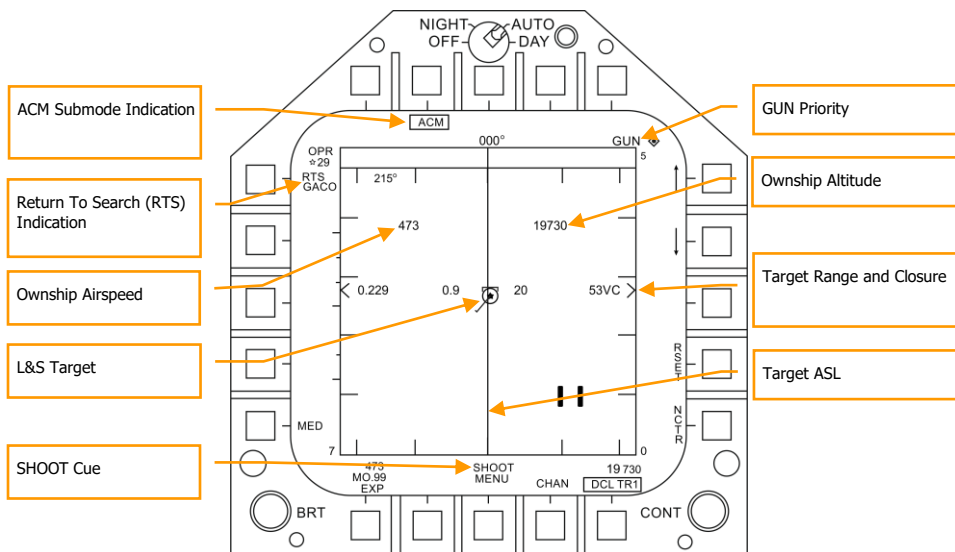

Figure 73. A/A GUNS Radar, Radar Tracking Mode

1. **ACM Submode Indication.** This is a reminder that if an RTS is commanded, it will return to the last ACM mode.
2. **GUN Priority.** When gun is the priority weapon, GUN is placed in the top right field of the RADAR display.
3. **Return To Search (RTS) Indication.** When the RADAR is in STT mode, the search mode that is entered when an STT lock is disengaged is displayed.
4. **Ownship Airspeed.** This is displayed when at a 5 nm RADAR range.
5. **Ownship Altitude.** This is displayed when at a 5 nm RADAR range.
6. **L&S Target.** When the target is locked in STT and set as the Launch and Steering (L&S) target, its air speed in Mach is to left and of the star symbol and altitude in thousands of feet to the right. When tracked in STT, its aspect pointer is displayed as a line coming from the target symbol.
7. **Target Range and Closure.** The target closure velocity and range is displayed along the right side range scale.
8. **Target ASL.** The L&S target will have an Azimuth Steering Line (ASL) running vertically through the target symbol.
9. **SHOOT Cue.** The shoot cue is displayed until target miss distance exceeds 30 feet. The shoot cue is provided when the below criteria have been satisfied:
 - A/A Gun is selected
 - All firing constraints are satisfied
 - RADAR is in STT on the target
 - Target is inside gun Rmax for the selected round type (MK-50 or PGU-28)

- Target center is within 20 feet of an imaginary line connecting the 1G and 9G pippers of the Foresight cue (maximum 20 feet miss distance)

AIM-9 Sidewinder Air-to-Air Missile

The AIM-9 is a short-range, infrared-guided missile best used in a dogfight. It is fire-and-forget and can be used with and without a sensor-slaved lock. The primary indication of a seeker lock is a higher-pitched lock tone and the SHOOT cue. The seeker can also be uncaged to ensure the seeker is tracking the target when it has first been sensor-slaved to the target.

Note that the AIM-9 can be decoyed by flares and it's a good idea to ensure you have a good seeker lock before launching an AIM-9 with flares in the seeker field of view.

To select the AIM-9, press down on the Weapon Select Switch on the Control Stick [Left Shift + S]. Doing so will also automatically activate A/A Master Mode. To launch an AIM-9, press the Trigger on the Control Stick [Space Bar].

Instant Action Mission Practice: Hornet AIM-9 Sidewinder

How to Use the AIM-9 Summary

1. Master Arm switch to ARM
2. Weapon Select Switch to AIM-9
3. Select ACM RADAR submode
4. Flying to place target in the ACM RADAR scan mode, as displayed on the Heads Up Display (HUD), over the intended target to lock it on RADAR when at 5 nautical miles or closer
5. Fly to place the Steering Dot inside the ASE/NIRD Circle and squeeze the trigger when you see the SHOOT cue over the Target Designation (TD) box on the HUD

IR Cool Switch

On the right side of the instrument panel is the IR COOL switch. For the infrared seeker in the nose of the AIM-9 to function best, it must first be cooled down to increase sensitivity and reduce background noise. This is done with the IR COOL switch. Place this switch in the NORM position to cool the seekers.

If the switch though is in the OFF position, cooling will still be sent to the AIM-9 seekers if there is no weight on wheels, the Master Arm switch is set to ARM, and AIM-9 is selected as the priority weapon.

There is enough coolant to last three hours.

AIM-9 on the SMS Page

Regardless of which AIM-9 version the pilot selects, the SMS page will appear the same when the AIM-9 is selected. The SMS page is accessed through the TAC menu DDI page, or it can automatically be called up by selecting AIM-9 from the Weapon Select Switch. The selected AIM-9 on the SMS page is indicated by the SEL indication above or below the station. In the case of a dual launcher, it will be indicated as either the L (left) or R (right) rail. For example: L SEL would indicate the left rail in the indication as the priority station.

For this Early Access release of DCS: F/A-18C Hornet, we have three versions of the AIM-9. Each has a unique alpha numeric indication on the SMS page.

- AIM-9L = 9L
- AIM-9M = 9M
- AIM-9P = 9P

You can cycle through all AIM-9 loaded stations with repeatedly selecting AIM-9 on the Weapon Select Switch.

Unlike the other air-to-air weapons, there are no unique AIM-9 functions on the SMS page.

The SMS page presents the following indications:

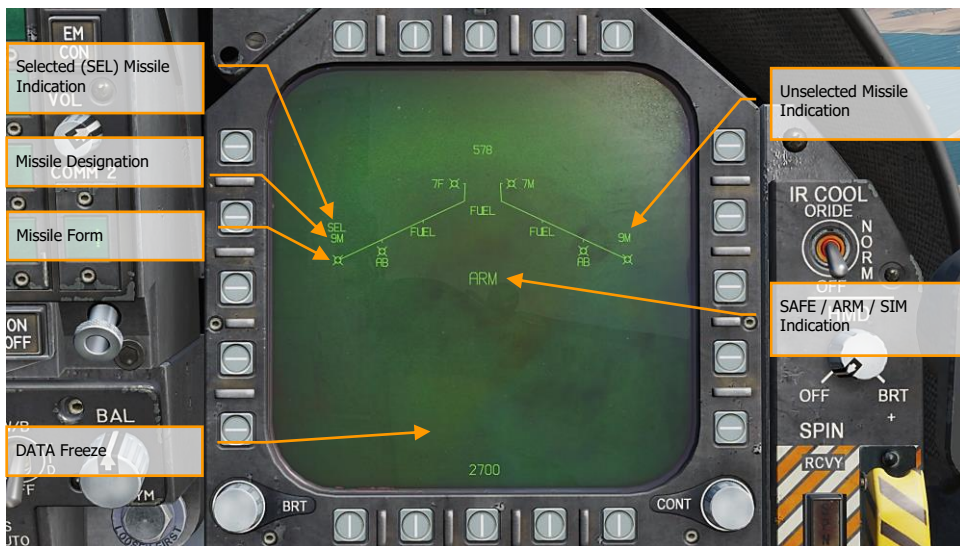

Figure 74. AIM-9 SMS Page

1. Missile Form
2. Selected (SEL) Missile Indication

3. Unselected Missile Indication
4. SAFE / ARM Indication
5. Data Freeze
6. Missile Designation

AIM-9 HUD

There are three primary presentations of the AIM-9 HUD:

- Not locked and no RADAR acquisition mode
- Not locked but in a RADAR acquisition mode
- RADAR locked

Not Locked and No RADAR Acquisition Mode (Seeker Boresight Mode)

When the AIM-9 is selected without a RADAR lock and no RADAR acquisition mode is active, the AIM-9 seeker boresight reticle is indicated on the HUD. To use the AIM-9 in this manner, the pilot will fly the aircraft and place the seeker boresight reticle over an aerial target until the audio threshold is exceeded and; the angle of coincidence is no more than 15 degrees of aircraft boresight; and the seeker is uncaged. a high-pitched lock tone is heard. With seeker lock acquired, pulling the trigger on the Control Stick will launch the missile.

When the AIM-9 seeker is locked on a target, it can be uncaged by pressing the Cage/Uncage button on the Throttles to allow the seeker lock on and follow the target within the confines of the missile seeker's field of view. This is a useful tool to ensure the seeker is tracking the desired target.



Figure 75. AIM-9 HUD, Seeker Boresight

1. AIM-9 Seeker Boresight Reticle
2. AIM-9 Selected and Armed Cue
3. Number of remaining AIM-9

This is a stealthy way to conduct an AIM-9 attack as it can be done without use of RADAR.

Not Locked but in RADAR Acquisition Mode

When employing the AIM-9 in close range combat, one of the RADAR Air Combat Maneuvering (ACM) auto acquisition modes can be used to lock a target and then slave the AIM-9 seeker to that target. To select the ACM modes, press the Sensor Control Switch forward. Once in ACM mode, three ACM modes are available:

- Boresight (BST) Sensor Select switch Sensor Select switch forward
- Vertical Acquisition (VACQ) Sensor Select switch aft
- Wide Acquisition (WACQ) Sensor Select switch left

These are explained in greater detail in the RADAR Air-to-Air Modes section of this Early Access Guide.

When in an ACM mode, the RADAR will indicate that it is in ACM mode and the specific ACM acquisition mode.

When a target is within the scan zone of the select auto acquisition mode, it will automatically be locked in a Single Target Track (STT) mode and the HUD will change to the AIM-9 sensor locked target mode. Use the best ACM acquisition mode to match the combat situation.

Please refer to the RADAR chapter for an explanation of the RADAR ACM modes.

RADAR Locked Mode

Upon locking a target with the AIM-9 as the priority weapon, the HUD will change to provide useful information regarding target location, weapon ranges, and other data to assist in a successful engagement. While the RADAR is in Single Target Track (STT) mode, the RADAR range scale will automatically adjusted based on the range to the locked target.

Elements of the AIM-9 HUD with RADAR lock include:

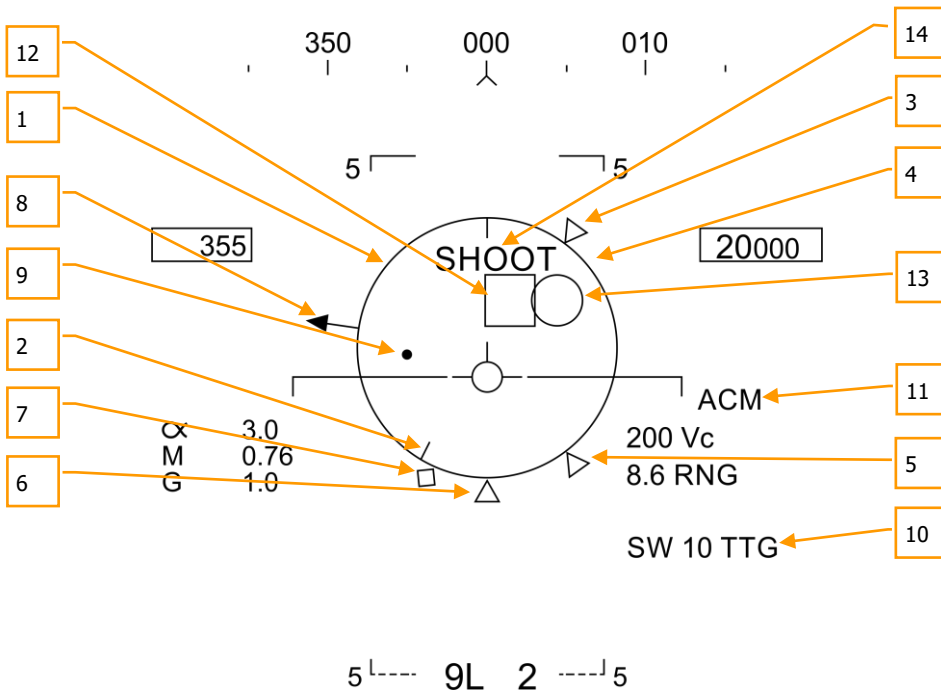

Figure 76. AIM-9 HUD, Radar Locked Target

1. **Normalized In-Range Display (NIRD) / Allowable Steering Error (ASE) Circle.**
The NIRD circle is centered on the aircraft waterline and relative range markers are displayed inside and outside of the circle. Relative range is calculated from the 12 o'clock

- position and increases clockwise. Rather than changing in size of the NIRD/ASE circle based on target intercept changes, the Steering Dot rate of change is adjusted.
2. **Relative Target Range.** Relative range of the target on the NIRD circle in relation to the missile range cues.
 3. **Minimum Launch Range.** Computed minimum launch range for the priority AIM-9.
 4. **Gun Maximum Range.** Indicated the maximum range for a valid gun shot and more than 12,000 feet.
 5. **No Escape Range (Rne).** This is the calculated range at which the target will remain within maximum range even if the target turns instantaneously 180 degrees aspect.
 6. **Maximum Launch Range (Rmax).** Computed maximum range of the missile against the locked target.
 7. **Raero.** Maximum aerodynamic range is displayed when the launch aircraft has more velocity than the missile, but the missile is still capable of a 5 G maneuver.
 8. **Target Aspect Angle Pointer.** Displays relative target heading.
 9. **Steering Dot.** The Steering Dot in conjunction with the NIRD/ASE circle indicates lead angle steering to the locked target. The pilot should fly to place the Steering Dot inside the NIRD/ASE circle to satisfy lead angle computations. The Steering Dot will flash when within 15 degrees of the RADAR's azimuth limit and when within 5 degrees of the RADAR's elevation limit.
 10. **AIM-9 Time of Flight.** Displays the calculated time in seconds before launch for missile to reach locked targets. After launch, Time To Go (TTG) and SW suffix are added indicate calculated missile time to impact.
 11. **ACM Submode Cue.** ACM is displayed when the system is in an ACM submode.
 12. **Target Designator (TD).** This box indicates the line of sight between the aircraft and the primary locked target. If the locked target is outside the HUD field of view, the TD box flashes. If the target is identified as hostile, the box is rotated 45-degrees to create a diamond symbol and an inverted "V" symbol is placed over the diamond.
 13. **AIM-9 Seeker Circle.** Indicates the seeker head position of the AIM-9. If the seeker is pointed outside the HUD field of view, the circle flashes. When the AIM-9 is slaved to the locked RADAR target, the TD box and AIM-9 Seeker Circle will coincide.
 14. **Shoot Cue.** The word "SHOOT" is displayed above the TD box/diamond when AIM-9 shoot conditions are satisfied. If the locked target is in the no escape zone (Rne), the Shoot Cue flashes.

With a RADAR lock on the target for an AIM-9 launch, several pieces of important information are presented on the RADAR display. Much of the information on the RADAR mirrors that on the HUD.

Note that when the target is outside the HUD field of view, the Target Locator Line appears and points in the direction of the target. Additionally, degrees to the target is displayed next to the arrow.

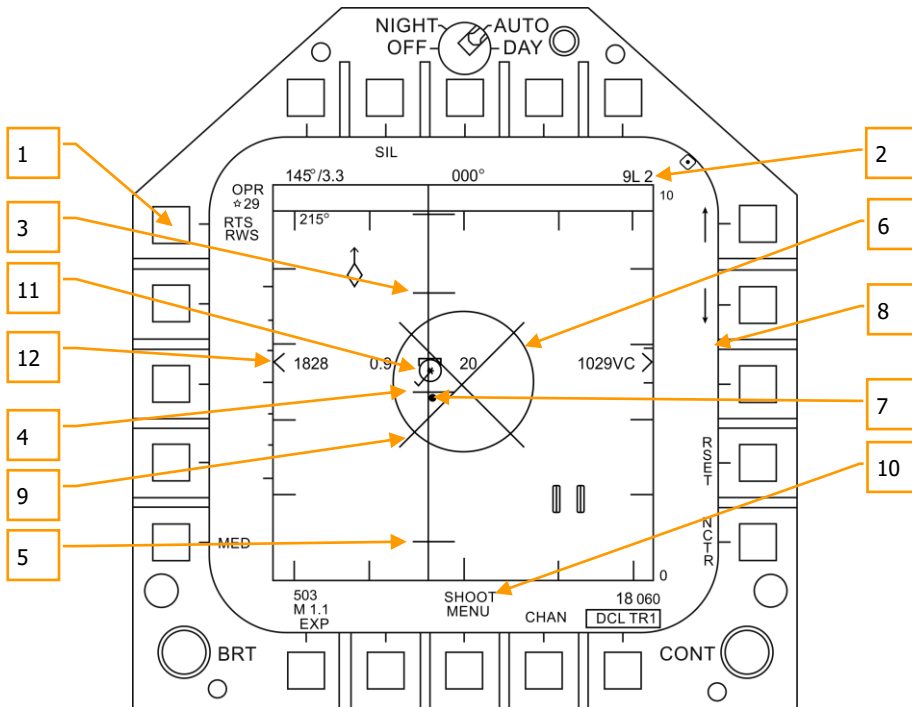

Figure 77. AIM-9 RADAR, RADAR Locked Target

1. Return to Search (RTS) indication with RWS to be the return mode
2. Priority weapon and number remaining
3. Rmax
4. Rne
5. Rmin
6. ASE Circle
7. Steering Dot
8. Target Closure Velocity and Range
9. Breakaway "X"
10. Shoot Cue
11. Locked target in STT RADAR mode with airspeed in mach to the left, altitude in thousands of feet to the right, and velocity vector line. The Star symbol indicates that is the Launch and Steering (L&S) target
12. Altitude Differential

Note that the range cues on the HUD and attack RADAR mirror each other, but use a different presentation format:

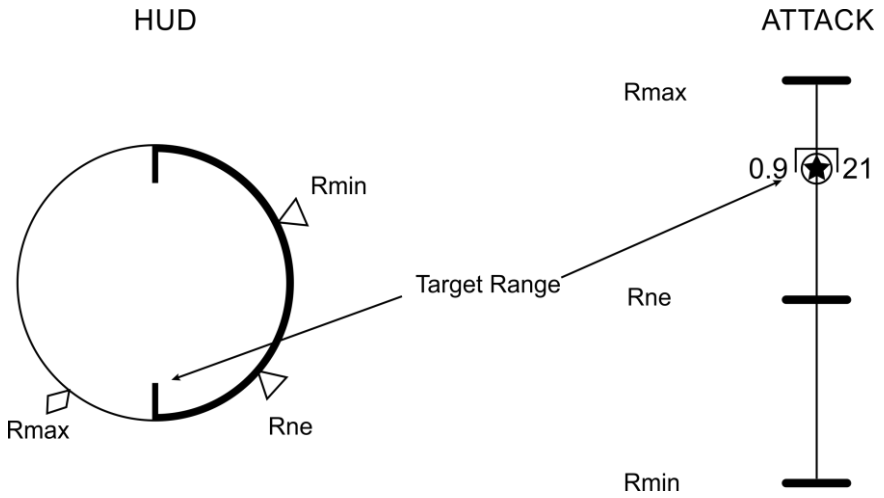

Figure 78. Weapon Range Cues

AIM-7 Sparrow Air-to-Air Missile

The AIM-7 Sparrow is a Semi-Active RADAR Homing (SARH) missile that requires the RADAR to be tracking the target in Single Target Track (STT) mode the entire missile time-of-flight (Home-On-Jam being the exception). The AIM-7 has a large warhead and can engage targets beyond visual range as well as in close combat. The AIM-7 can be a deadly missile in close combat when combined with the RADAR ACM submodes.

The AIM-7 also has the FLOOD mode that allows it to launch and guide on a non-locked target, and it has a LOFT option for extended range.

To select the AIM-7, push forward on the Weapon Select Switch on the CONTROL STICK [Left Shift + W]. Selecting AIM-7 will automatically place the Master Mode in A/A.

The RADAR must be in Single Target Track (STT) mode in order to support guidance for an AIM-7. This can be done by pressing the Cage/Uncage button less than .8 seconds when there is an L&S target. Alternatively, you may press right on the Sensor Control switch when the RADAR is on the right DDI and the target TDC is already over the target on the RADAR.

NOTE: FLOOD and HOJ modes will not be available at Early Access launch, but they will be implemented later.

Instant Action Mission Practice: Hornet AIM-7 Sparrow

How to Use the AIM-7 Summary

1. Master Arm switch to ARM
2. Weapon Select switch to AIM-7
3. Designate target on RADAR to Single Target Track (STT) or select ACM RADAR submode and fly to place target in ACM RADAR scan mode, as displayed on the Heads Up Display (HUD), over the intended target to lock it on RADAR when at 5 nautical miles or closer
4. Fly to place the Steering Dot inside the ASE Circle and squeeze the trigger when you see the SHOOT cue over the Target Designation box on the HUD.

AIM-7 SMS Page

When selected as the priority weapon, the Stores pages includes the following information and options for the AIM-7:

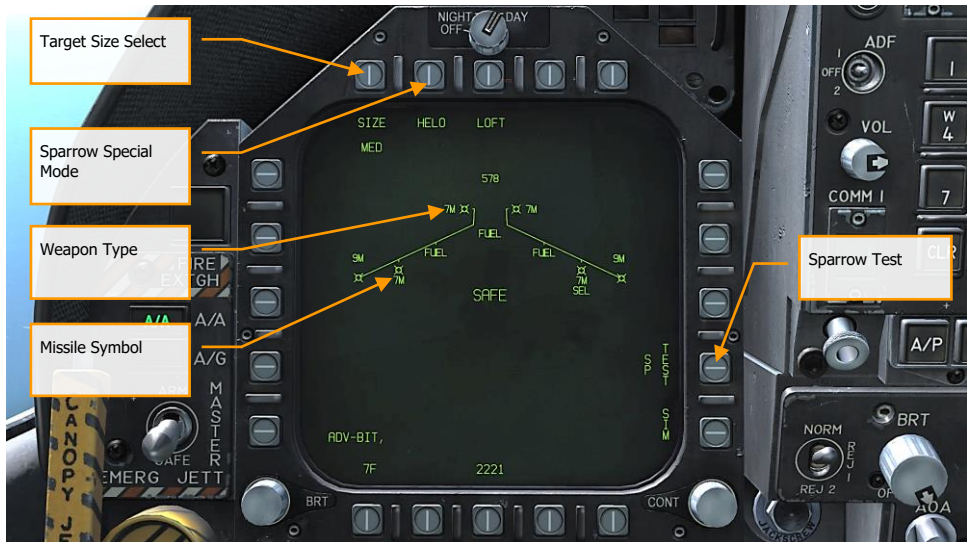

Figure 79. AIM-7 SMS Page

1. **Missile Symbol.** Missile shape indicating AIM-7 loaded on the station.
2. **Weapon Type.** AIM-7 alphanumeric, which will either be 7F or 7M. The priority AIM-7 will have a SEL below this indication.
3. **Target Size Select.** Allows selection of missile fuzing based on intended target size. This can be cycled between SML, MED, and LRG. When this option button is pressed, each option is shown as a separate Option Select Button across the top of the page.
4. **Sparrow Special Mode.** This mode is only used for engagement of helicopters. When enabled, HELO appears below the Option Select Button. When disabled, an "X" is through the HELO legend.
5. **Sparrow Test.** All Sparrows must be tuned before they are employed. The initial tune occurs at the end of the RADAR Operational Readiness Test and after the SMS has applied power to the missile for approximately three minutes. The three minute warm-up time begins at the completion of the SMS BIT and weapon inventory. When the tune process begins, the TEST portion of the SP TEST option is boxed. The RADAR provides a missile compatible PDI sample to the missile. The SMS receives a Missile Ready Signal from each

missile that has been successfully tuned. Successful tune of a Sparrow is indicated by the removal of the "X" overlaying the 7F or 7M on the SMS page.

AIM-7, No RADAR Tracking

When an AIM-7 is the priority weapon and no target has been designated with a sensor, the AIM-7 HUD includes the following indicators in addition to the standard air to air mode HUD indications:

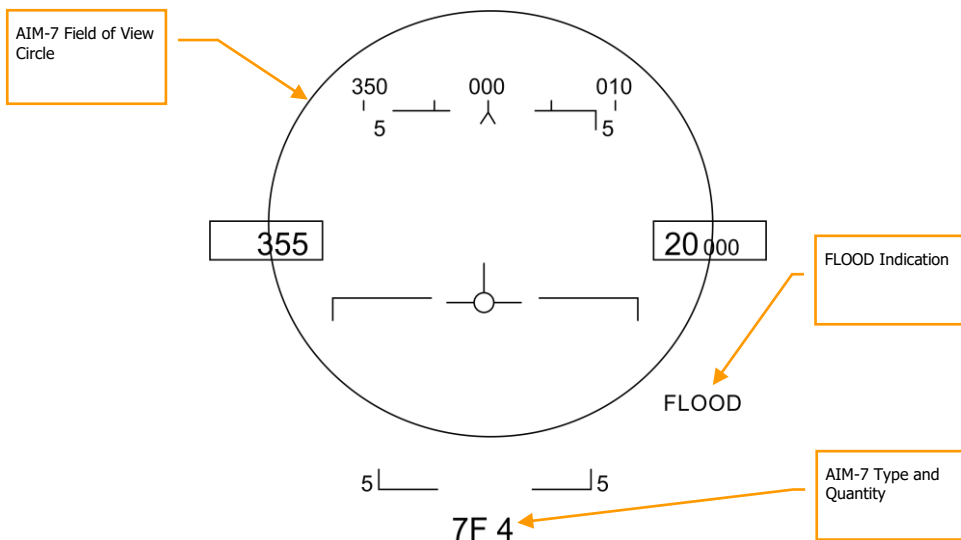

Figure 80. AIM-7 HUD, No Target

1. **AIM-7 Field of View Circle.** Displayed when AIM-7 is in priority but no target has been designated. This also delineates the FLOOD antenna coverage field of view.
2. **AIM-7 Type and Quantity.** Displays the type of AIM-7 in priority (7M or 7F) and the number of the missile type remaining.

When AIM-7 is selected as the priority weapon, the RADAR will default to the followings settings unless a SET profile was already created:

- 140 degree azimuth
- 4-bar elevation scan
- 40 nm range

- 8 seconds aging
- Interleaved PRF

When the AIM-7 is the priority weapon but no target has been designated, the RADAR includes the following information:

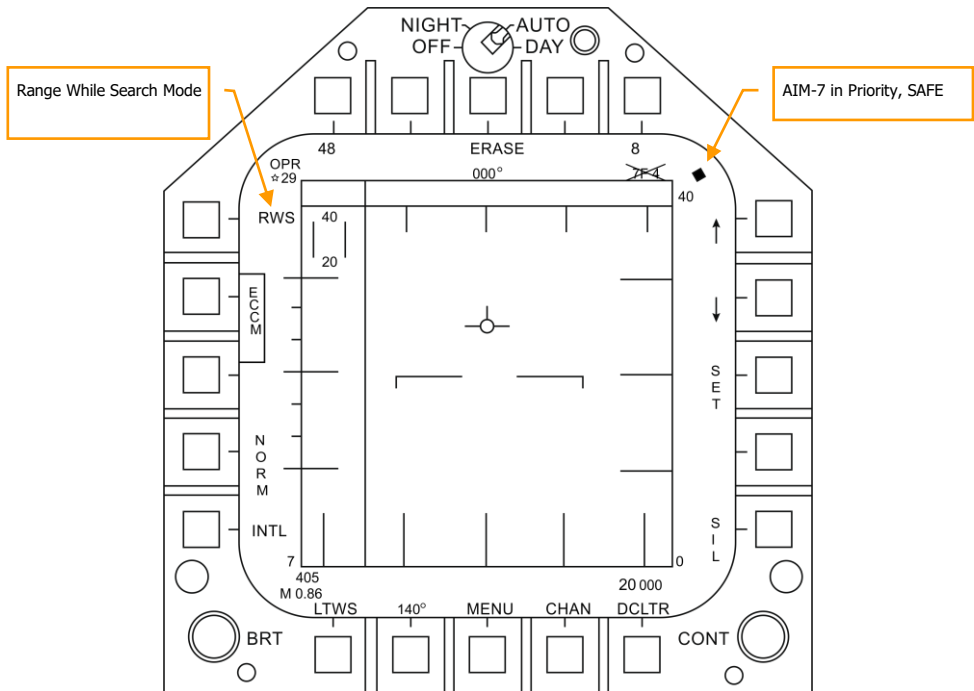

Figure 81. AIM-7 Radar, No Lock

AIM-7, RADAR Tracking

With an L&S trackfile created for a target, additional engagement information is displayed on the HUD and RADAR. As with the AIM-9 sensor-locked mode, this additional information includes multiple weapon range cues, target closure and aspect, target range, and other information to help provide a successful AIM-7 engagement.

If though the target is being tracked but not in Single Track Target (STT) mode, a "GO STT" cue is displayed on the HUD to remind the pilot to achieve an STT lock before launching the missile.

Components of the AIM-7 HUD with a RADAR-locked target include:

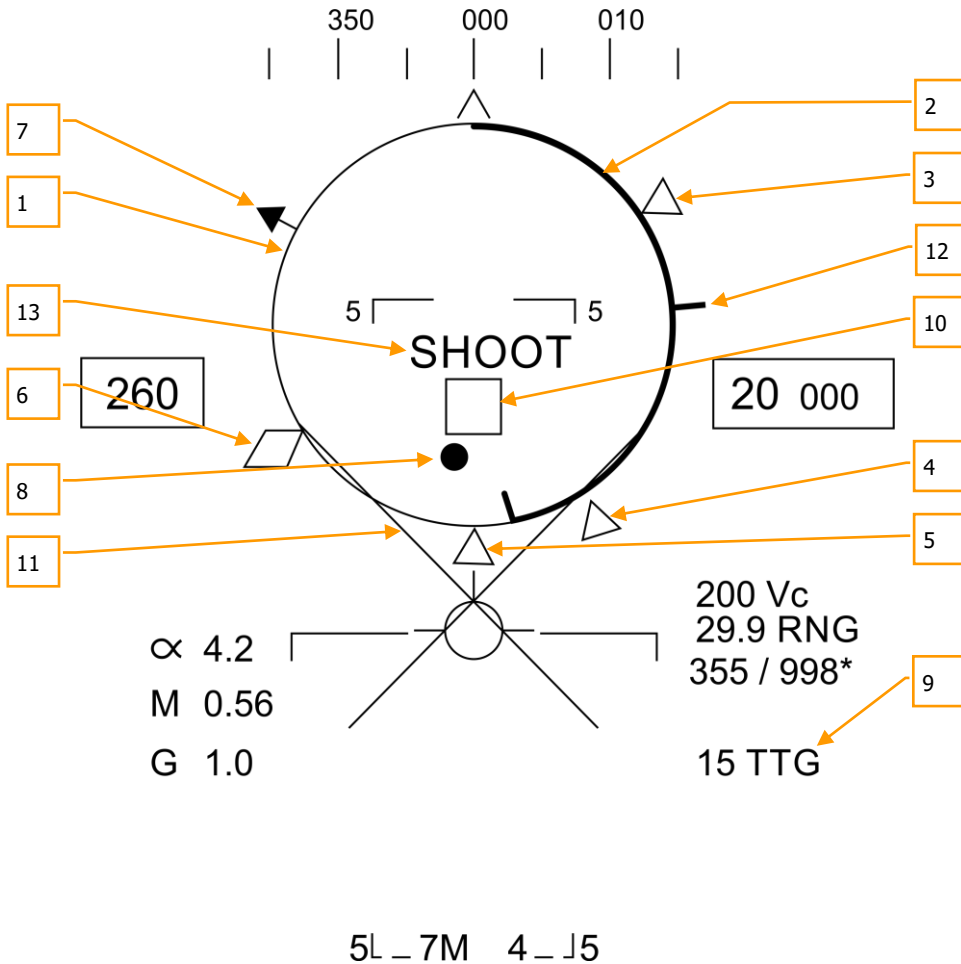

Figure 82. AIM-7 HUD with L&S Target

- 1. Normalized In-Range Display (NIRD) / Allowable Steering Error (ASE) Circle.**
 The NIRD circle is centered on the aircraft waterline and relative range markers are displayed inside and outside of the circle. Relative range is calculated from the 12 o'clock position and increases clockwise.

Rather than changing in size of the NIRD/ASE circle based on target intercept changes, the Steering Dot rate of change is adjusted.

2. **Relative Target Range.** Relative range of the target on the NIRD circle in relation to the missile range cues.
3. **Minimum Launch Range.** Computed minimum launch range for the priority AIM-7.
4. **No Escape Range (Rne).** This is the calculated range at which the target will remain within maximum range even if the target turns instantaneously 180 degrees aspect.
5. **Maximum Launch Range (Rmax).** Computed maximum range of the missile against a locked, non-maneuvering target.
6. **Raero.** Maximum aerodynamic range is displayed when the launch aircraft has more velocity than the missile, but the missile is still capable of a 5 G maneuver.
7. **Target Aspect Angle Pointer.** Displays relative target heading.
8. **Steering Dot.** The Steering Dot in conjunction with the NIRD/ASE circle indicates lead angle steering to the locked target. Fly to place the Steering Dot inside the NIRD/ASE circle to satisfy lead angle computations. The Steering Dot will flash when within 15 degrees of the RADAR's azimuth limit and when within 5 degrees of the RADAR's elevation limit.
9. **AIM-7 Time of Flight.** Displays the calculated time in seconds for missile to reach the locked target. After launch, Time To Go (SP TTG) suffix is added indicate calculated missile time to impact.
10. **Target Designator (TD).** This box/diamond indicates the line of sight between the aircraft and the primary locked target. If the locked target is outside the HUD field of view, the TD box flashes. A "GO STT" cue is displayed below the TD if the RADAR is not tracking the target in Single Track Target mode.

If RADAR tracking on the target is lost, the TD box will be hashed to indicate the RADAR is in memory (MEM) mode and extrapolating its position to reacquire it.

If the target is identified as hostile, the box is rotated 45-degrees to create a diamond symbol and an inverted "V" symbol is placed over the diamond.

11. **Breakaway X.** Displayed when range to target is less than Minimum Range Cue.
12. **Gun Maximum Range.** Indicates the maximum range for a valid gun shot and more than 12,000 feet.
13. **Shoot Cue.** The word SHOOT is displayed above the TD box when AIM-7 shoot conditions are satisfied. If the locked target is in the no escape zone (Rne), the Shoot Cue flashes

Note that when the target is outside the HUD field of view, the Target Locator Line appears and points in the direction of the target.

Additionally, degrees to the target is displayed next to the arrow.

AIM-7 with L&S Target

With an AIM-7 as the priority weapon and the target locked in STT on the RADAR, the RADAR provides the following useful information that is pertinent to an AIM-7 engagement:

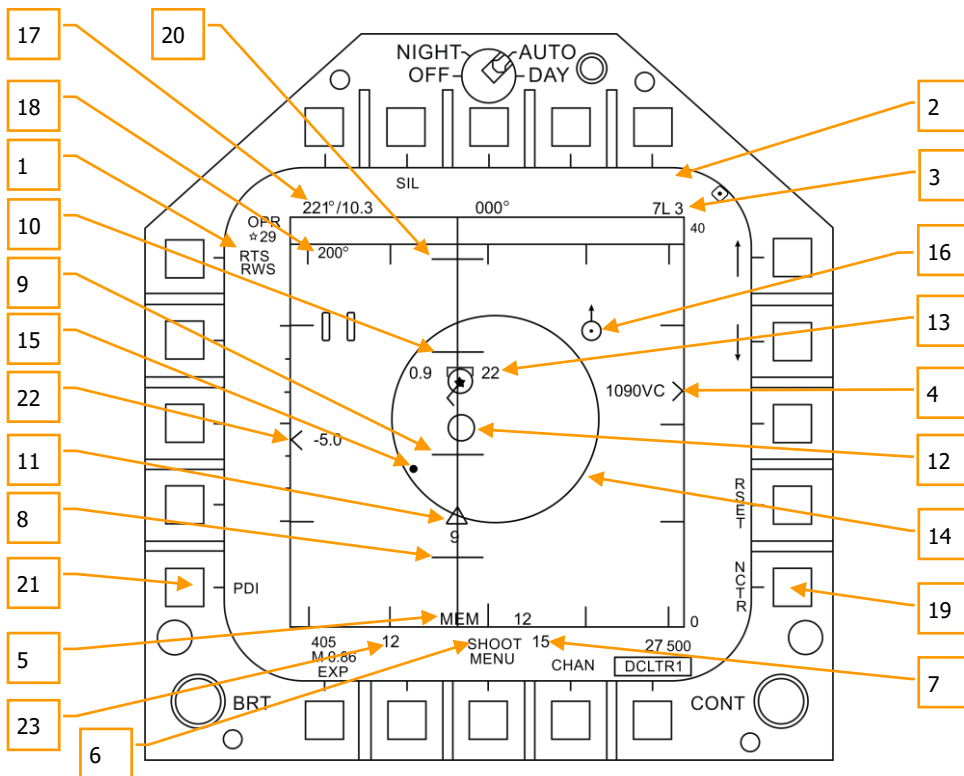

Figure 83. AIM-7 RADAR with L&S Target

1. **Return to Search (RTS) Indication.** Single Track Target (STT) mode with Return To Search (RTS) indication.
2. **FLOOD Indication.** This field will display the FLOOD indication when the AIM-7 is commanded to FLOOD mode.
3. **Selected Weapon and Number Remaining.** AIM-7 as Priority Weapon and Remaining Number.
4. **Target Range and Closure Indication.** The range of the target is indicated in reference to the range scale and selected RADAR range display setting. Left of the caret, closure velocity (Vc) is indicated.
5. **Memory Mode indication and Memory Track Time.** If the RADAR loses track on the target, it will automatically enter memory (MEM) mode. During this period, the RADAR will

attempt to reacquire the target and the amount of time the RADAR is in memory mode is displayed in seconds to the right.

6. **Shoot and Lost Cue.** When the target is within Rmax range, the Shoot Cue appears as solid. When the target range is within Rne, the Shoot Cue flashes.
7. **Missile Time of Flight.** This indicates the estimated Time Of Flight for the un-launched missile to reach the locked target. Once the missile has been launched, the missile fly-out indication displays missile time to go.
8. **Rmin.** Calculated minimum launch distance.
9. **Rne.** Calculated no escape distance.
10. **Rmax.** Calculated maximum range distance.
11. **AIM-7 Fly-Out indication and Time to Go.** Graphically displays the fly-out of the AIM-7 and the estimated Time To Go (TTG) until target intercept.
12. **AIM-7 Max Seeker Range Cue.** This small circle appears on the azimuth steering line when the AIM-7 is in STT and LOFT is selected. The cue indicates the range at which the AIM-7 Semi-Active RADAR Homing (SARH) seeker can guide of RADAR illumination off the locked target. If LOFT is not selected, the cue only appears when the SARH seeker range is less than the target range and the target is between Rmin and Rmax.
13. **Locked Target.** Around the L&S star symbol, target information is displayed that includes Acceleration Vector, Target Aspect Angle Pointer, Tracked Target indication, Target Altitude in thousands of feet, and Target Airspeed in Mach.

The Acceleration Vector is displayed in the direction of acceleration, perpendicular to the target heading vector when the target exceeds 3 Gs. The length of the Acceleration Vector lengthens with greater target G.

14. **Allowable Steering Error (ASE) Circle.** Static ASE circle for the AIM-7.
15. **Steering Dot.** In conjunction with the ASE circle, the Steering Dot indicates lead angle steering to the locked target. Fly to place the Steering Dot inside the ASE circle to satisfy lead angle computations. The Steering Dot will flash when within 15 degrees of the RADAR's azimuth limit and when within 5 degrees of the RADAR's elevation limit.
16. **Air-to-Air Waypoint with North Arrow.** This is only displayed when selected from the HSI A/AWP option and the waypoint is within the RADAR's field of view.
17. **Target Bearing and Range to Air-to-Air Waypoint.** If an air-to-air waypoint has been created from the HSI/DATA/A/C sublevel, the bearing and range to that waypoint is indicated in this field.
18. **Target Heading.** Flight heading of the L&S target.
19. **Non-Cooperative Target Recognition (NCTR).** When enabled, the RADAR will attempt to identify the L&S target based on unique RADAR reflections.
20. **Rloft.** Maximum range using a LOFT launch.
21. **Pulse Doppler Illuminator (PDI) indication.** When the AIM-7 is launched, it requires PDI illumination to track the target. PDI is displayed when this illumination occurs.
22. **Target Altitude Differential.** Displays the difference in altitude between the target and ownship in thousands of feet.

23. **Maximum Aspect Cue.** This cue can range from 1 to 18 and indicates shot quality. The higher the number, the greater probability of missile intercept.

HORNET DEFENSIVE SYSTEMS

As this is Digital COMBAT Simulator, you will often find yourself as the target of enemy weapon systems. The Hornet includes several defensive systems to assist you in your fight to keep alive that includes expendable countermeasures of chaff and flares and Electronic Countermeasures (ECM).

Instant Action Mission Practice: Hornet Defensive Systems

The lower console instrument group is dominated by the countermeasures dispensing system. This system provides protection against tracking RADAR, air-to-air and surface-to-air missiles. Protection is provided by ejecting chaff, flare, or jammer payloads (GEN-X).

The ALQ-165 Airborne Self Protection Jammer (ASPJ) is the onboard Electronic Countermeasure (ECM) system. The ALQ-165 detects and deceives threat pulse fire control and guidance RADARs and has four operating modes: standby, receive, transmit, and built in test. This ECM system detects, processes, and transmits a simulated target echo for deception when a RADAR signal is received. The simulated echoes are recognized by the enemy RADAR as true target returns. Tracking RADAR then tracks a false target and breaks lock from the true target. Threat RADAR indications are indicated as both indicator lights and the RADAR Warning Receiver.

Integrated Countermeasures Control Panel (ICMCP)

The ICMCP replaces the old ALR-39 panel and moves many of the control functions to the DDI EW page.

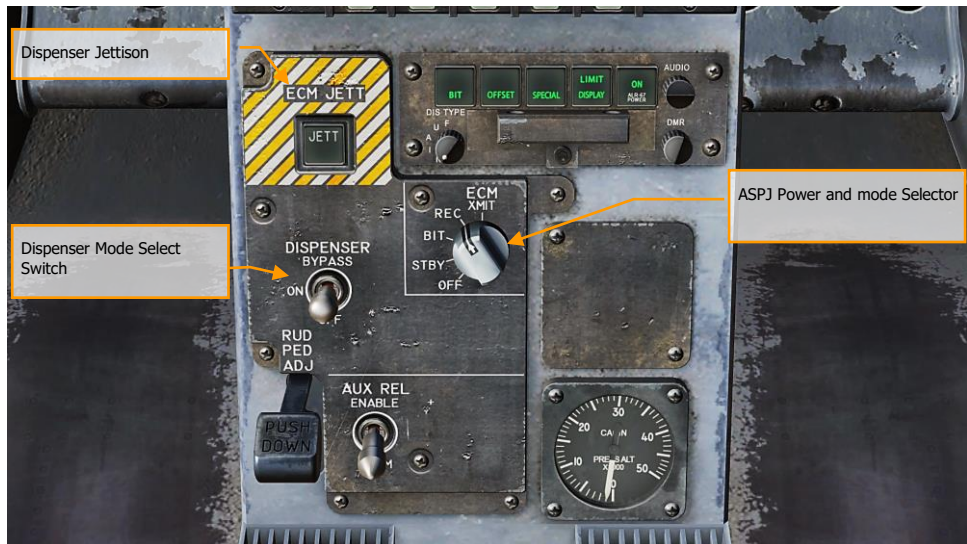

Figure 84. Integrated Countermeasures Control Panel

Elements of the ICMCP include:

- **Dispenser Jettison Button.** Pressing this button releases all chaff and flares onboard. This switch only works with no weight on wheels and the button will illuminate when pressed.
- **Dispenser Mode Select Switch.** This switch has three positions:
 - OFF: Turns the CMDS power off and ALE-47 legend on the EW page has an X through it. However, the ECM JETT button will still function.
 - ON: When set to on, there is a five second warm up period and a BIT is conducted. After five seconds, it is ready for operation. When in ON mode, the release modes of STBY, MAN, SEMI, and AUTO can be selected.
 - When first set to ON, SF TEST will appear for five seconds below the EW legends on the DDI EW page. After which, PBIT GO will be displayed for ten seconds. Once that is complete, OFF or the selected mode will be displayed.
 - BYPASS. This selection bypasses the countermeasure programmer and will release a single chaff or single flare based on the HOTAS countermeasure release command. When set to bypass, the ALE-47 indication on the DDI EW

page will have a dash through it and the EW page BIT element will indicate NOT RDY.

- **ASPJ Power and Mode Selector Knob.**
 - STBY. Once the ALQ-65 is turned on to STBY, it enters a four minute warm-up period. After four minutes, the STBY (green) light on the threat panel will extinguish.
 - BIT. Commands the ALQ-65 to perform a self-test. The ASPJ will cycle power and then provide a GO (green) or NO GO (yellow) light indication.
 - REC. System only detects and displays threat RADARs, no electronic attack is initiated though. The green REC light will illuminate when radio frequency energy has been detected. The REC light will also light during an ASPJ BIT.
 - XMIT. System detects and displays threats and then uses active electronic attack. The green XMIT light and green REC lights will light when the ALQ-65 is transmitting to jam a radar. A JAM cue will also be visible on the radar display.
 - OFF. Removes power from the ASPJ.



Figure 85. ASPJ annunciator panel

EW Page



Figure 86. EW Page

At the bottom of the countermeasure panel is the control indicator. This panel has the following functions:

- **ASPJ Power and Mode Indicator.** Based on the setting of the ALQ-165 ASPJ Power and Mode Selector, the ASPJ legend will be OFF below it when the ASPJ is set to OFF. When set to one of the other four modes, the mode is displayed below the ASPJ legend: XMIT, REC, STBY, or BIT.
- **Chaff Indicator.** This field indicates the number of chaff bundles remaining. A box is placed over the number when a chaff bundle is released.
- **Flare Indicator.** This field indicates the number of flares remaining. A box is placed over the number when a flare is released.
- **Decoy Indicator (O1 and O2).** GEN-X decoys can be carried in two bays, O1 and O2. The number of decoys per bay are indicated. When a decoy is released, the bay will be boxed.
- **ALE-47 Power and Program Indicator.** When the dispenser switch is set to ON, the selected release program type is displayed below the ALE-47 legend. There are 6 manual (MAN) programs that can be stored and edited. Semi-Automatic (S/A) and Automatic modes (AUTO) are also available that will select the a program to match the threat and allow the pilot to initiate a program (S/A) or have the CMDS initiate a program automatically (AUTO). To select manual (MAN) programs, successive presses of the STEP OSB will cycle through the programs and the name of the selected program will be

displayed below the ALE-47 legend (i.e. MAN 5). If semi-automatic mode is selected, S/A will be displayed and if automatic mode is selected AUTO will be displayed.

- If the ALE-47 is powered off from the ICMCP panel, then OFF will be displayed below the ALE-47 legend.
- When first set to ON, SF TEST will appear for five seconds below the EW legends on the DDI BIT page. After which, PBIT GO will be displayed (EW BIT complete). Once the BIT is completed, the OFF legend is removed.
- Pressing the ALE-47 OSB should box the ALE-47 legend and the C, F, O1, and O2 indications should appear on the along the top of the EW DDI page with the following values: C 14, F 18, O1 14, and O2 14.
- When the dispensers are set to Bypass, the legend will have a dash through it.
- **EW Power OSB.** Indicates power status of the ALR-67(V) system based on the Control Indicator Panel power button. When un-powered, the EW legend has OFF below it. Also when disabled, the EW mode, offset, limit, and HUD status indications on the EW page are removed.
- **EW HUD OSB.** Pressing this OSB 18 toggles EW information displayed to the head up display. Using two alphanumeric identifiers and stems extending from the EW symbols on the periphery of the HUD toward the center to better indicate relative azimuth. The stem indicates the threat level of the EW threat:
 - Non-critical/lethal stems are solid and short
 - Critical threat stems are solid and long
 - Lethal threat stems are dashed and long

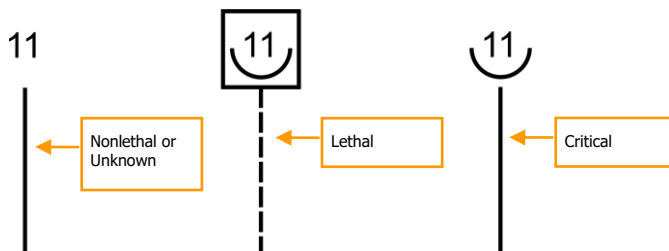

Figure 87. Threat level of the EW threat

In air-to-air, air-to-ground, and navigation modes, the six highest priority EW threats are indicated on the HUD. However, this can change based on radar activity and HUD REJECT setting.

- In Gun ACM mode or gun tracking mode, a maximum of three indications can be displayed.
- In AIM-7 tracking mode, a maximum of two indications can be displayed.
- In AIM-9 tracking mode, a maximum of one indication can be displayed.

If however HUD REJECT 1 is selected, and additional two indications can be displayed. If HUD REJECT 2 is selected, up to six indications can be displayed in all conditions.

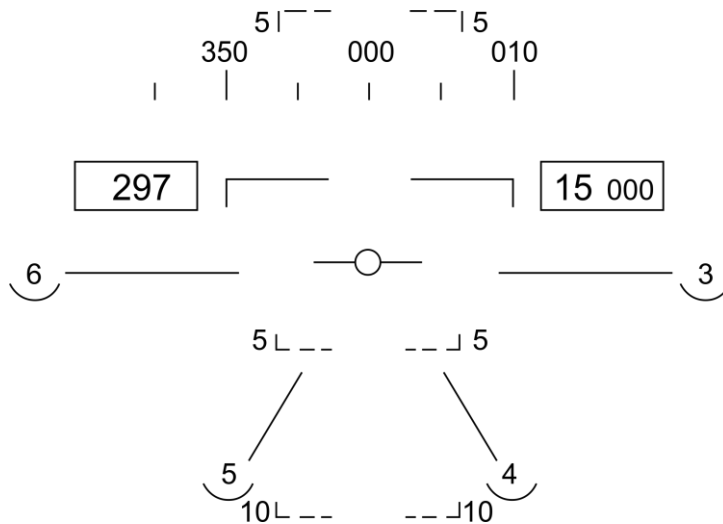

Figure 88. HUD REJECT

- **EW Status Indications.** Based on the enabling of the EW MODE, OFFSET, and LIMIT options on the Control Indicator Panel, the selection will be indicated in the bottom right portion of the EW page.
- **EW MODE OSB.** Successive presses of the mode OSB will cycle through the EW mode options:
 - **STBY.** The CMDS has power but cannot dispense countermeasures except for EW JETT.
 - **MAN.** Up to six manual programs can be selected and programmed using the PROG sub-level. Only on MAN mode are the STEP and PROG OSB options visible.
 - **S/A.** The CMDS will choose from a library to select the best program against the primary threat. The pilot though must consent to initiate the program.
 - **AUTO.** The CMDS will choose from a library to select the best program against the primary threat. The CMDS will automatically initiate the program.
- **ARM OSB.** When the ALE-47 OSB is pressed and boxed, the ARM legend is displayed. When the ARM OSB is pressed, the SAVE OSB will appear next to the STEP OSB. Additionally, new manual programming options will appear. To create a manual program, pressing the ARM OSB displays the CMDS PROG sub-level. Successive presses of the STEP OSB will cycle through the five, manual programs. The selected program can be seen in the center of the page (CMDS PROG x). Along the left side of the page, OSBs to select chaff (CHAF), flares (FLAR), GEN-X decoys (OTH1 and OTH2), release repeat (RRT), and

release internal (INT) parameters are displayed. Pressing one of these OSBs will box the legend and thereby select it for programming. Using the up and down arrows on the right side of the page, you may adjust the value of the selected program element. The value for each program element is displayed in the center of the page. Once complete, pressing the SAVE OSB will have the parameters to the selected program and pressing the RTN (return) OSB will return to the main EW page.



Figure 89. EW Programs

- **ALE-47 Program STEP OSB.** Manual programs can be cycles through (1-6) with successive presses of the STEP OSB. The selected program number is indicated below the ALE-47 legend at the top of the page.

The primary means for dispensing chaff and flares is with the countermeasures dispense switch on the throttle.

- **Flare / Rear.** Releases one flare from each of the left and right dispensers that contain a flare in a group of 10.
- **Chaff / Forward.** Released one chaff burst.

Azimuth Indicator

Detected RADARs by the ALR-67(V) are displayed on the Azimuth Indicator (aka RADAR Warning Receiver) and on the HUD when enabled.

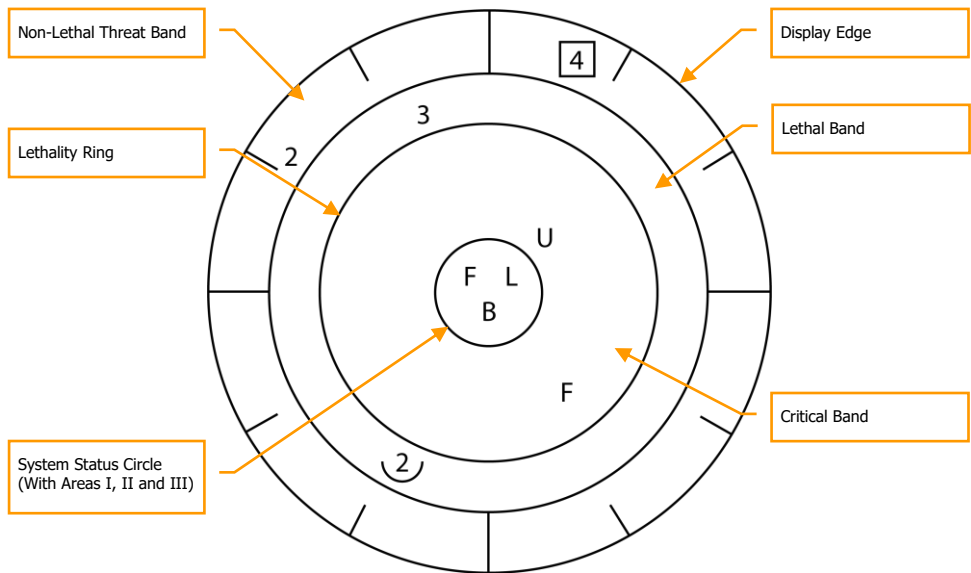

Figure 90. Azimuth Indicator

When a RADAR emitter is detected, the ALR-67(V) Azimuth Indicator visually indicates the RADAR signal source with a coded symbol. The coded symbol indicates the type of emitter detected, and its position on the azimuth indicator indicates the relative bearing to the emitter. The ALR-67(V) system detects multiple emitters and provides relative bearing to each emitter. Audio tones are produced as an advisory for emitter, or BIT status change. This will mirror the DDI EW page.

The emitter and status display is shown on the azimuth indicator when power is applied to the ALR-67(V) system. When an emitter is detected and analyzed by the ALR-67 system, an alphanumeric symbol representing the emitter is displayed. Certain types of emitters, when detected, are assigned unique alphanumeric symbols for display.

The azimuth position of the displayed emitter symbol represents the relative bearing of the emitter with respect to the nose of the aircraft. As an example, the image above shows a naval threat enhancement (boat symbol) at 40 degrees.

The display area of the azimuth indicator is divided into four unique areas listed below:

- Critical band
- Lethal band
- Nonlethal band
- Status circle

The critical band is the innermost band in which specific threats or modes of lethal threats are displayed. Azimuth tic marks are engraved in the outer most portion of the critical band. The tic marks are in 30 degree increments. The lethal band is the second band in from the outer most portion of the display. Emitters displayed in the lethal band are threats that have been determined to be lethal. The nonlethal band is the outermost band of the display. Emitter symbols in the nonlethal band represent unknown and friendly emitters. Known emitters that have been determined to be nonlethal are also displayed in the nonlethal band.

The status circle is in the center of the azimuth indicator and displays ALR-67(V) system status. The status circle is divided into three areas of display:

Upper left quadrant of circle (area I)
Upper right quadrant of circle (area II)
Bottom half of circle (area III)

- Area I displays the priority setting of the EW Mode as set on the EW page (N, I, A, U or F).
- Area II is either blank when ALR-67(V) system is operating in the full display mode, or displays the character L when operating in the display limit mode.
- Area III displays current ALR-67(V) Built-In Test (BIT) status. Area III is blank when there are no ALR-67(V) system failures. The character B is displayed when a failure is detected. The character T is displayed when a thermal overload has been detected in Countermeasures Computer or RADAR Receiver.

Any time a new emitter symbol is displayed on the azimuth indicator or an emitter symbol goes from a less lethal to a more lethal band, a status change tone is generated by the ALR-67(V) system. Special tones are also generated for specific threats or critical threat modes of operation. Threats no longer transmitting or going from a more lethal to a less lethal band do not cause a status change tone.

Right Instrument Panel Warning / Advisory / Threat Display Panel



Figure 91. Right Instrument Panel Warning / Advisory / Threat Display Panel

Working as part of the ALR-67, red warning lights at the top of the right instrument panel alert the pilot of the type of radar energy painting the aircraft:

AI: Hostile air intercept radar in lock mode (lethal band)

CW: Hostile radar in continuous wave mode and probably guiding a missile (critical band)

SAM: Surface-to-Air Missile radar that has locked on (critical band)

AAA: Radar directed anti-aircraft artillery.

DISP. The ALE-47 has a program ready for the detected threat and is waiting for start consent. In addition, a DISPENSE cue will be displayed on the HUD.

GO and NO. BIT test result from when the Dispense switch is set to ON or BYPASS. BIT will take five seconds.

BIT

When conducting an EW BIT, both graphical and audio tests will be run.

On both the EW page and azimuth indicator, the following test images will be displayed with three seconds between each.

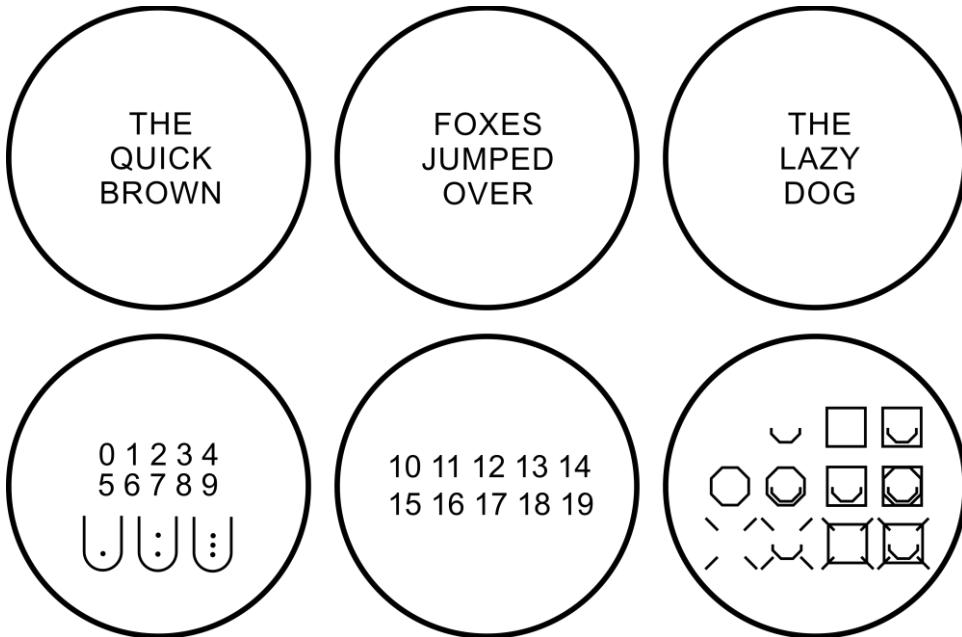

Figure 92. EW BIT Test Images

In parallel, each of the ALR-67 tones would be played. These include:

- New Contact (waterfall)
- AAA
- Missile Launch
- Radar Lock
- Power Up

Control Indicator Panel



Figure 93. Control Indicator Panel

At the bottom of the countermeasure panel is the control indicator. This panel duplicates the functions on the DDI EW page. This panel has the following functions:

- **POWER Pushbutton Switch.** Turns the ALR-67(V) system on and off. When pressed to the on position, the POWER, DISPLAY, SPECIAL, OFFSET AND BIT light will illuminate.
- **DISPLAY Pushbutton Switch.** When pressed, LIMIT light on DISPLAY pushbutton switch comes on and emitter display is limited to the six highest priority emitters. .L. will be displayed in status circle area II on azimuth indicator. Pressing again deselects the option.
- **OFFSET Pushbutton Switch.** When pressed, ENABLE light on OFFSET pushbutton switch comes on, and overlapping symbols on azimuth indicator are separated to ease reading of display. Pressing again deselects the option.
- **BIT Pushbutton Switch.** When pressed, enables current BIT status to be displayed on the azimuth indicator. FAIL light on BIT pushbutton switch will come on whenever periodic BIT detects a failure. Pressing again deselects the option.
- **DMR Control.** Controls brightness of the lamps on the control-indicator. Clockwise rotation increases brightness, counterclockwise rotation decreases brightness.
- **DIS TYPE Switch.** Selects priority of emitter type to be displayed. Switch setting to N (normal), I (intercept), A (AAA), U (unknown), or F (friendly) are also displayed in status circle area I on azimuth indicator.

HOTAS

On the throttle, there is a three place switch for countermeasures.

- **Center.** This is the OFF position and no dispense action is taken.
- **Aft.** When in BYPASS mode, this will release one flare. If not in BYPASS mode or OFF, AUTO, S/A, or MAN mode will initiate the program.
- **Forward.** When in BYPASS mode, this will release one chaff bundle. If not in BYPASS mode or OFF, it will initiate manual program 5.

Good hunting!

The Eagle Dynamics and Belsimtek Teams

EAGLE DYNAMICS © 2018